

PLAN USER GUIDE



Release 26.3
Last Updated: 04 May 2026

Information in this document is subject to change without notice. Companies, names and data used in examples are fictitious.

Copyright ©2026 by InEight. All rights reserved. No part of this document may be reproduced or transmitted in any form or by any means, electronic or mechanical, for any purpose, without the express permission of InEight.

Microsoft Windows, Internet Explorer and Microsoft Excel are registered trademarks of Microsoft Corporation.

Although InEight Plan has undergone extensive testing, InEight makes no warranty or representation, either express or implied, with respect to this software or documentation, its quality, performance, merchantability, or fitness for purpose. As a result, this software and documentation are licensed “as is”, and you, the licensee are assuming the entire risk as to its quality and performance. In no event will InEight be liable for direct, indirect, special, incidental or consequential damages arising out of the use or inability to use the software or documentation.

Release 26.3
Last Updated: 04 May 2026

This page intentionally left blank.

CONTENTS

CHAPTER 1 – QUANTITY TRACKING OVERVIEW	11
1.1 Plan Quantity Tracking Overview	12
1.1.1 InEight Plan Work Flow	12
1.1.2 Quantity Tracking Terminology	13
1.1.3 Components	15
1.1.4 Component Attributes	18
1.1.5 Claiming Schemes	19
1.1.6 Quantities Sent to InEight Control	21
CHAPTER 2 – GENERAL NAVIGATION	23
2.1 Page Navigation	24
Launch Quantity Tracking	27
2.1.1 Standard Grid vs Data Block View	29
2.1.1.1 Standard Grid view	29
2.1.1.2 Data Block view	30
2.1.2 URL Filtering	30
2.2 Columns	31
2.2.1 Move Columns	32
Move Columns	32
2.2.2 Add and Remove Columns	32
Add Additional Columns	32
2.2.3 Sort Columns	35
Sort Columns	35
2.2.4 Filter Columns	36
Filter Columns	36
2.2.5 Saved Filters	37
Create a Saved Filter	38
2.3 Viewsets	41
Create a Viewset	41
2.3.1 Send a viewset	42
Send a viewset	43
2.3.2 Delete a viewset	45
Delete a viewset	45
2.4 Data Blocks	47

2.4.1 Component Details Data Block	47
2.4.2 Step Data Blocks	47
2.5 Query Builder	49
2.5.1 Add a Query	49
Add a Query	49
2.6 CBS tree	51
2.7 AWP Filter	52
CHAPTER 3 – CLAIMING SCHEMES	55
3.1 What is a Claiming Scheme?	56
3.1.1 What is the purpose?	56
3.1.2 Setting up a Claiming Scheme	57
3.1.3 Claiming Scheme Solutions	59
3.1.4 Account Code Assignment	60
3.2 Claiming Scheme Creation	61
Build a Claiming Scheme	62
3.2.1 Import and Export	65
Import Claiming Schemes	65
Export Claiming Schemes	65
3.3 Claiming Scheme Management	67
3.3.1 Assigning Claiming Schemes	67
Assign a WBS to a Claiming Scheme	68
3.3.2 Edit Claiming Schemes	71
Edit a Claiming Scheme	71
CHAPTER 4 – COMPONENT MANAGEMENT	75
4.1 InEight Plan Workflow - Component Management	76
4.2 Component Creation from Scratch	76
4.2.1 Create Components	76
4.2.2 Types of Components	77
4.2.2.1 Assembly Components	78
4.2.2.2 Contract Components	79
4.2.3 Methods of Creating Components	79
4.2.4 Component Attributes	80
4.2.4.3 Validated Fields	80
4.2.4.4 Location	80
4.2.4.5 Engineering	81
4.2.4.6 Using Component Attributes	82
4.2.4.7 Split Contract Components	82

4.2.4.8 Validated lists in Field attributes	83
4.2.4.9 Schedule Components	84
4.2.4.10 Project Values	85
4.2.5 Component Creation	86
Create a Component from Scratch	86
Copy an Existing Component	89
Split an Existing Component	90
Bulk Edit Components	91
4.2 Step by Step 1 – Bulk Delete Components	91
4.3 Component Creation from Import	91
4.3.1 Import Template	92
Create Components from Excel Import	93
4.4 Component Audit Log	99
4.4.1 Summary	99
4.4.2 Considerations	100
4.5 Default Components	100
4.5.1 What are Default Components?	100
4.5.2 Enable and Refresh Default Components	101
4.5.2.1 Considerations for Enabling Default Components	101
4.5 Step by Step 1 – Enable and Refresh Default Components	102
4.5.2.2 Delete default components	102
4.6 Component Export History	103
CHAPTER 5 – QUANTITY CLAIMING	105
5.1 InEight Plan Workflow - Quantity Claiming	106
5.2 Quantity Claiming	106
5.2.1 Process for claiming quantities	106
5.2.2 Why claim at a component level?	107
5.2.3 Claiming in the Standard Grid View	107
Quantity Claiming (Standard Grid View)	108
5.2.4 Over claim component quantity	110
5.2.5 Claiming in the Data Blocks View	112
Quantity Claiming (Data Blocks View)	112
5.2 Step by Step 1 – Apply Installed Quantity to All	112
5.3 Edit Claimed Quantities	113
5.3.1 Quantity Joined	114
5.3.2 Quantity Editing	114
Edit Claimed Quantity	115
Batch Edit Claimed Quantity	118

STEP-BY-STEP PROCEDURES

Launch Quantity Tracking	27
Move Columns	32
Add Additional Columns	32
Sort Columns	35
Filter Columns	36
Create a Saved Filter	38
Create a Viewset	41
Send a viewset	43
Delete a viewset	45
Add a Query	49
Build a Claiming Scheme	62
Import Claiming Schemes	65
Export Claiming Schemes	65
Assign a WBS to a Claiming Scheme	68
Edit a Claiming Scheme	71
Create a Component from Scratch	86
Copy an Existing Component	89
Split an Existing Component	90
Bulk Edit Components	91
4.2 Step by Step 1 – Bulk Delete Components	91
Create Components from Excel Import	93
4.5 Step by Step 1 – Enable and Refresh Default Components	102
Quantity Claiming (Standard Grid View)	108
Quantity Claiming (Data Blocks View)	112
5.2 Step by Step 1 – Apply Installed Quantity to All	112
Edit Claimed Quantity	115
Batch Edit Claimed Quantity	118

EXERCISES

This page intentionally left blank.

CHAPTER 1 – QUANTITY TRACKING OVERVIEW

1.1 PLAN QUANTITY TRACKING OVERVIEW

As one of the applications within the InEight portfolio of products, InEight Plan is a tool for engineers and superintendents to plan work and track quantities during the execution of their project.

Plan is organized into two modules:

Plan Modules	
Work Packaging	Creating and managing work packages.
Quantity Tracking	Creating and managing components and claiming schemes. Claiming completed quantities.

1.1.1 InEight Plan Work Flow



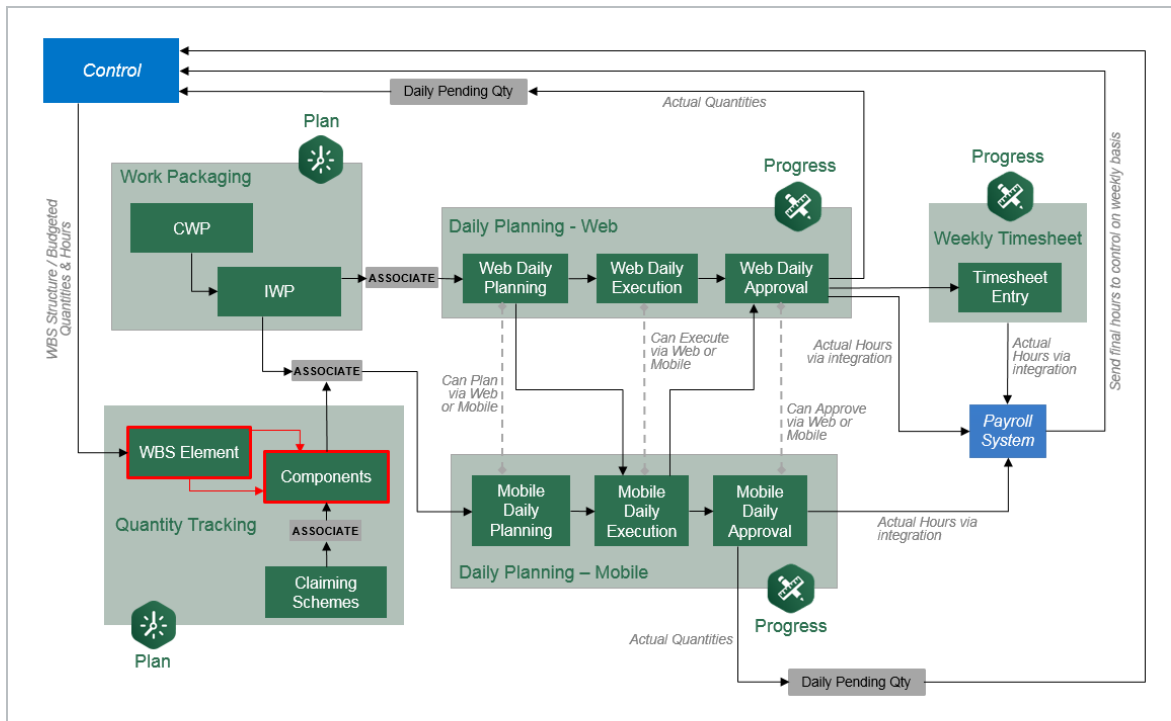

This course focuses on the Quantity Tracking module of InEight Plan.



1.1.2 Quantity Tracking Terminology

Plan Quantity Tracking uses some key terminology to describe how the work is broken down for tracking.

The table below defines each of the key terms you should know.

Term	Definition	Managed In..
CBS (Cost Breakdown Structure)	Hierarchy of budgeted work activities (cost items) in a project.	 Control
WBS (Work Breakdown Structure)	Code assigned to terminal cost items for tracking purposes.	 Control
ACS (Account Code Structure)	Standard Classification code used for benchmarking similar types of work between projects.	 Control
Component	Item or element of work used for maintaining quantities.	 Plan
Claiming Scheme	A method used for tracking component progress via use of sublevel tasks (steps).	 Plan

The relationship between these terms is shown in the following diagram:

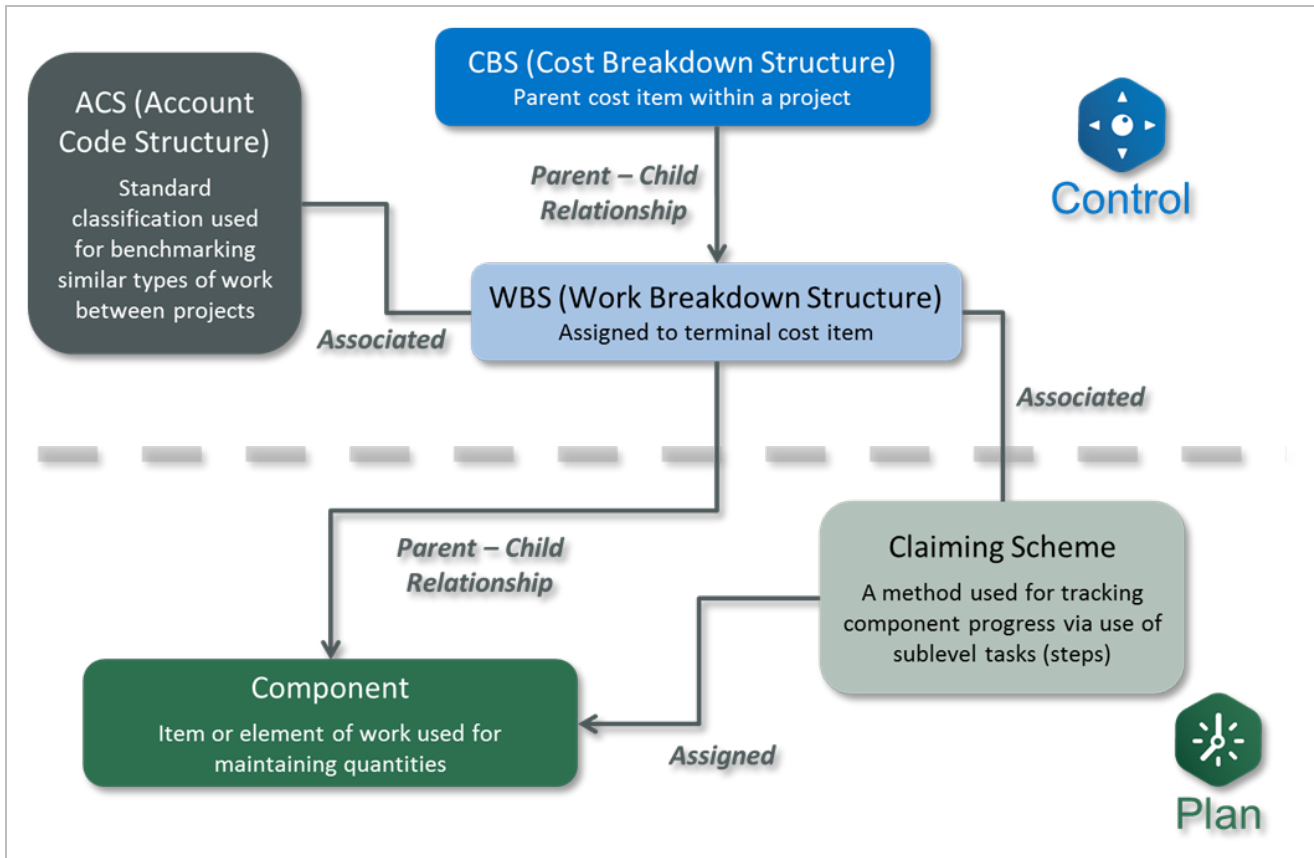

Scenario

You are a structural steel field engineer responsible for accurately tracking installation progress for a steel structure project. See image below. The structural steel cost item is measured in tons, but steel is installed by piecemark, and it needs to be tracked as such. There are multiple steps to structural steel installation that are all coded to the same cost code, and you need a way to track completion of the different steps as well. You also want to easily communicate to your foreman what he needs to accomplish each day to stay on schedule and on budget.

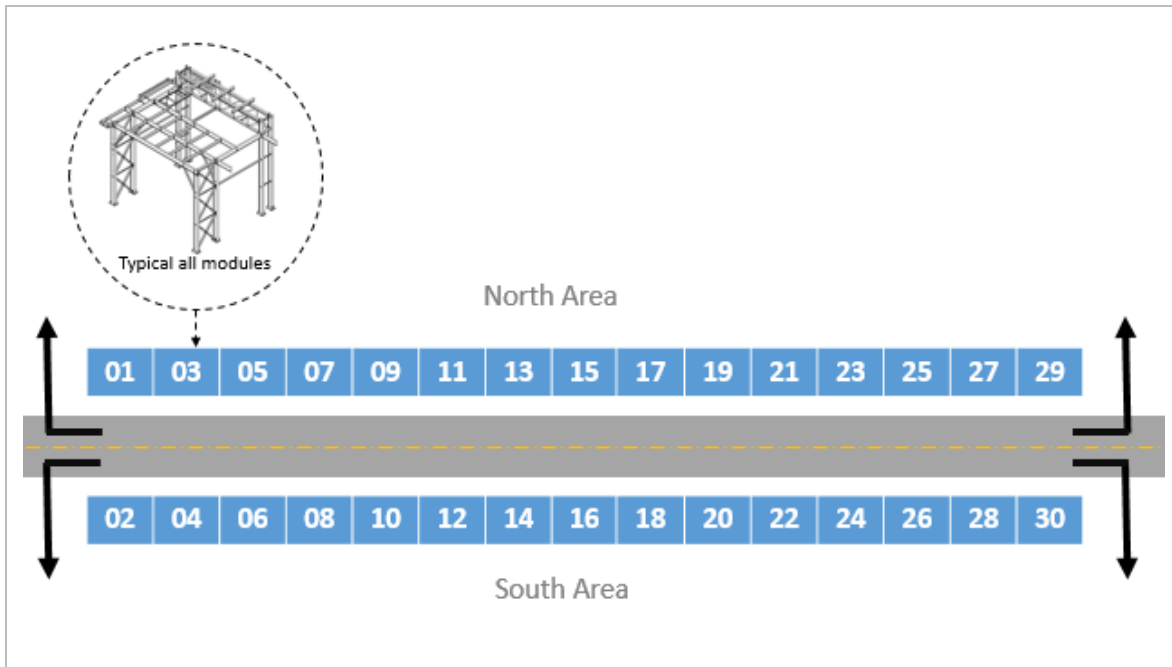

The image above depicts a layout for a steel structure project. The project consists of erecting 30 separate steel structures on opposite sides of a road. Each structure or module has been assigned a number 1-30.

1.1.3 Components

Within the InEight Control application, cost items are identified by a WBS Phase Code (commonly referred to as simply the WBS). A unique WBS is assigned to each cost item in the CBS, including superior and terminal items. The WBS codes can be set up to be automatically assigned or manually input.

Tasks			Task Det.. < >		
<input type="checkbox"/>	CBS Position	Description	WBS Phase Code	Forecast TO Qty	UOM
<input type="checkbox"/>	1	Job Overhead	1002	1.00	Lump Su..
<input type="checkbox"/>	2	Earthwork	1069	10,000.00	CY
<input type="checkbox"/>	3	Concrete	1071	10,000.00	CY
<input type="checkbox"/>	▼4	Structural Steel	1073	1,000.00	Ton
<input type="checkbox"/>	4.1	Erect Steel - Heavy	1074	800.00	Ton
<input type="checkbox"/>	4.2	Erect Steel - Light	1005	200.00	Ton
<input type="checkbox"/>	4.3	Bolted Connections	1006	2,000.00	Ea
<input type="checkbox"/>	▼5	Materials	1084	1.00	Each

In InEight Plan, the Quantity Tracking module allows you to break down quantities into more manageable tasks to track and claim against. You accomplish this by breaking down your WBS Phase Code quantity into smaller pieces called components.

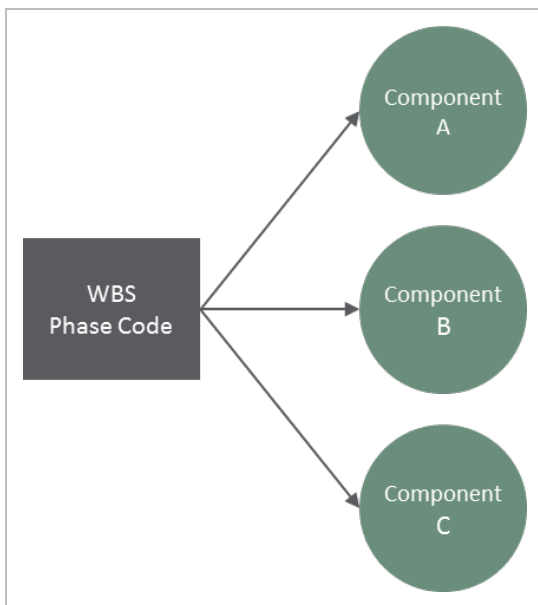

Referring to the scenario above, your project has an 'Erect Steel – Light' cost item with a WBS Phase Code of 1005, as seen in the CBS register of the Control application.

The screenshot displays the 'Steel Structure Job (105091)' interface. At the top, there are navigation elements for 'Control' and 'Workspaces'. Below this, the 'CBS' register is active. The interface is divided into two main sections: 'Tasks' and 'Task details'.

Tasks Table:

Checkbox	CBS position	Description
<input type="checkbox"/>	1	Job Overhead
<input type="checkbox"/>	^ 2	Earthwork
<input type="checkbox"/>	2.1	Earthwork Review
<input type="checkbox"/>	2.2	Earthwork
<input type="checkbox"/>	3	Concrete
<input type="checkbox"/>	^ 4	Structural Steel
<input type="checkbox"/>	4.1	Erect Steel - Heavy
<input type="checkbox"/>	4.2	Erect Steel - Light
<input type="checkbox"/>	4.3	Bolted Connections
<input type="checkbox"/>	4.4	Module XXX - Erect...

Task details Table:

WBS phase code	Forecast (T/O) quantity	UoM
1002	1.00	Lump Sum
1069	10,000.00	CY
1003	1.00	Each
1004	10,000.00	CY
1071	10,000.00	CY
1073	1,000.00	Ton
1074	350.00	Ton
1005	200.00	Ton
1006	2,000.00	Ea
1087	800.00	Ton

For tracking purposes, in the Quantity Tracking module of Plan, you can break down the 'Erect Steel – Light' WBS Phase Code into distinct components by structural steel piecemark:

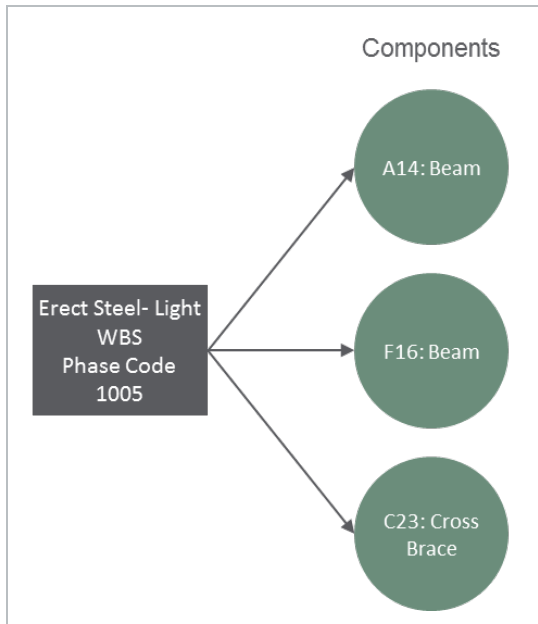

Each component has a measured quantity:

Component	Quantity
A14: Beam	0.44 Tons
F16: Beam	0.45 Tons
C23: Cross Brace	0.26 Tons

The sum of the quantities for each component adds up to the total quantity for the assigned WBS.

1.1.4 Component Attributes

Components can have a myriad of attributes assigned to them to help organize and store pertinent information that can be used for filtering and reporting. These include but are not limited to:

- Schedule ID
- Discipline
- Area
- System
- Customizable Attributes

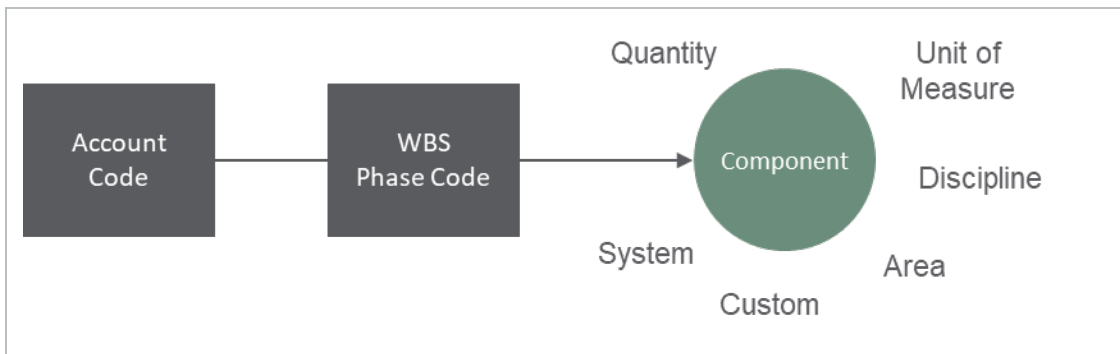

In Lesson 4 – Component Management, you will learn how to create components either through import from an Excel template or by creating them manually.

1.1.5 Claiming Schemes

Claiming schemes break components down further, to a sequence of steps, so that foremen can track the individual steps as the installation of the component progresses. Each step has a weighted rule of credit, based on percentages, that will progress the overall component.

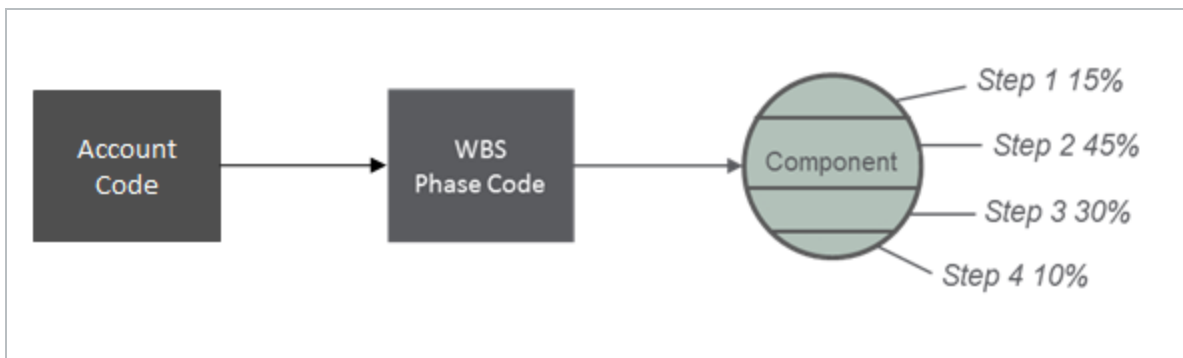

Claiming schemes can be assigned at either the component, WBS, or Account Code level. If a claiming scheme is assigned at the WBS level, then every component that is assigned to that WBS will automatically inherit the same claiming scheme.

The level at which claiming schemes will be assigned (Account Code, WBS, or component) will typically be dictated during project initiation in the project settings. See Lesson 3 – Claiming Schemes for more details on assigning claiming schemes.

For example, you may break down the 'A14: Beam' component into the following steps for tracking in the field:

Claiming Scheme for 'A14: Beam' Component		
Step	Description	Percentage
Step 1	Shakeout/Transport	15%
Step 2	Erect/Bolt Up	45%
Step 3	Final Torque	30%
Step 4	QC Verification	10%

The diagram below shows how the claiming scheme relates to the component, WBS Phase Code, and Account Code.

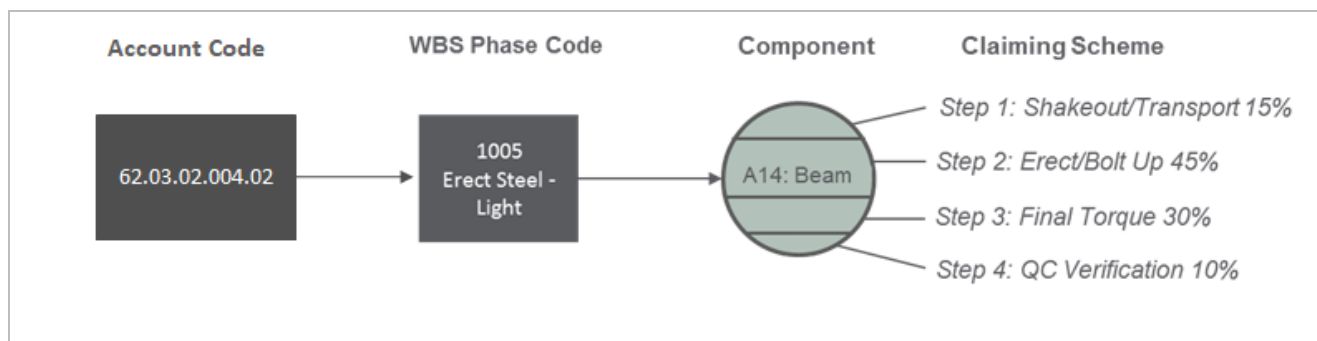

In the field, the foreman can indicate when each step has been completed for a specific component. By indicating Step 1: Shakeout/ Transport is complete for 'A14: Beam', this will claim the component is 15% completed. After syncing this information to InEight Control, 15% of the quantity for A14: Beam will be added to the total quantity complete for that WBS code which will drive the earned value.

The diagram below shows the flow of quantity claiming through components and claiming schemes.

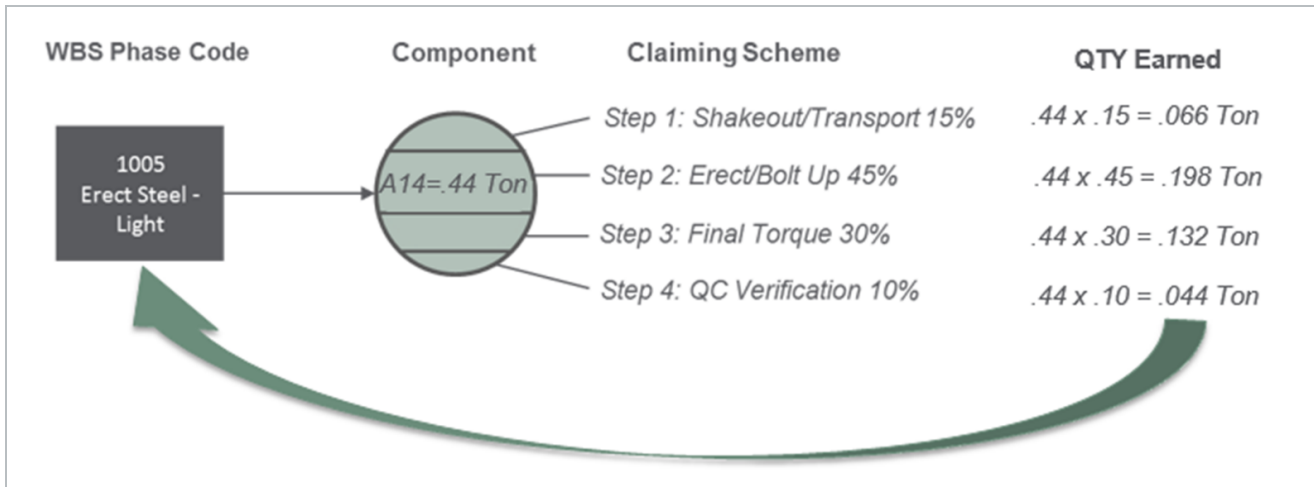

1.1.6 Quantities Sent to InEight Control

The quantities tracked at the component level will “roll up” to the assigned WBS Phase Code and be available for progress analysis and forecasting in the Control application. [Learn more about syncing in the Control Knowledge Library.](#)

In this example, the quantities claimed for steel components roll up to the ‘Erect Steel – Light’ WBS item, which then gets sent to Control upon request.

This page intentionally left blank.

CHAPTER 2 – GENERAL NAVIGATION

2.1 PAGE NAVIGATION

To launch the Plan application, you must first open the InEight software in your web browser, using the link provided by your manager or facilitator.

Open the **All projects & organizations** page from the Main menu.

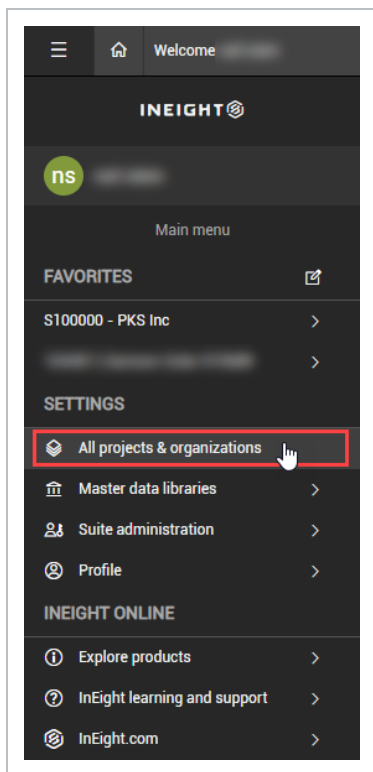

On the Projects tab you can select any project you are associated with. If your project is not shown on the initial screen, you can search by selecting the **Search** icon in the top right corner.

ID	Name	Stat...	Organization	Created by	Created on	Original contract ...	Contract number	Date project start...	Contract date	Original contract ...	Original duration
					07/06/2021 12:29:34 ...			09/09/2019	09/09/2019	09/09/2019	1
					07/06/2021 9:03:18 AM						
					07/06/2021 10:13:31 ...						
					07/09/2021 10:50:48 ...						
					07/12/2021 9:15:06 AM		2021.06.09	08/30/2021	06/09/2021		
					08/04/2021 11:22:04 ...						
					06/01/2020 2:05:49 PM			06/09/2021		05/09/2023	700
					07/05/2021 12:00:54 ...				07/07/2021		
					07/28/2021 10:13:22 ...						
					07/19/2021 5:22:47 PM						
					07/28/2021 12:18:33 ...						
					07/29/2021 10:43:07 ...						
					07/07/2021 6:49:42 AM						
					08/03/2021 9:37:21 PM						
					07/08/2021 11:17:10 ...						
					07/02/2021 4:45:19 AM						
					07/21/2021 7:09:31 AM						
					06/21/2021 8:04:56 AM						
					06/07/2021 8:51:43 AM			06/02/2021			
					06/17/2021 5:25:49 AM						
					12/04/2020 5:59:29 PM			06/01/2021			
					12/04/2020 5:59:29 PM						
					12/04/2020 5:59:29 PM						
					12/04/2020 5:59:29 PM			08/04/2021			
					13/04/2020 6:40:26 PM						

When you select a project, it takes you to the Project home page.

From here, you can launch Plan Quantity tracking in several ways:

- Clicking the Quantity tracking Launch application tile

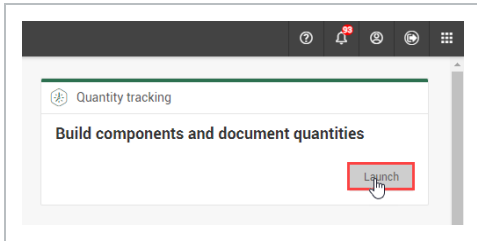

- Selecting Plan > **Quantity tracking** from the left menu

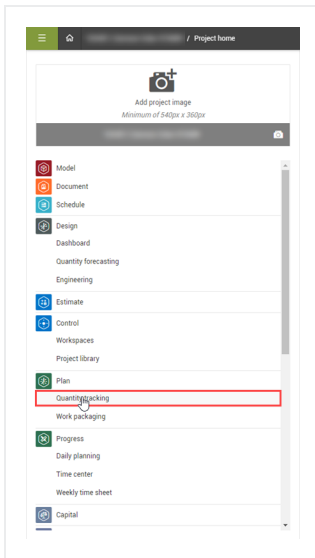

- Selecting Plan > **Quantity tracking** from the second-level drop-down menu for a specific organization or project at the top of the page

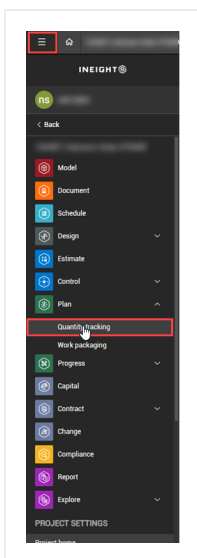

- Selecting Plan > **Quantity tracking** from the app launcher icon in the upper-right corner of the page

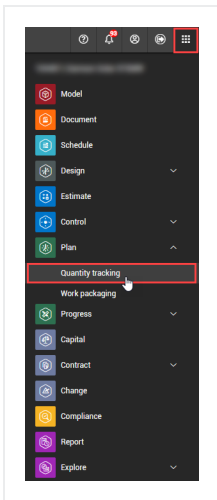

The following steps walk you through launching Quantity tracking using the second-level drop-down menu at the project level.

Launch Quantity Tracking

1. From the Projects tab of the **All projects & organizations** page, click on the project name hyperlink to select a project.
This opens the Project home page.
2. From the Project home page, click the **main menu** icon, and then click the **project name** to open the second-level menu.
3. From the second-level drop-down menu, open the **Plan** drop-down menu, and then select **Quantity tracking**.

This brings you to the Quantity tracking page.

Overview - Quantity Tracking Home Page (Standard Grid)

	Title	Description
1	Actions	Contains available actions for the current tab.
2	Left toolbar	Options to add, edit, bulk edit, delete, copy, and split components.

Overview - Quantity Tracking Home Page (Standard Grid) (continued)

Title		Description
3	Grid view options	<ul style="list-style-type: none"> • Row density: Lets you change the spacing between rows. • View as data blocks: Changes to data block view.
4	Views	Lets you create, save, change and share views.
5	Import, Export, and Save claiming	<ul style="list-style-type: none"> • Options to import and export data to Microsoft Excel. • Lets you save claimed quantities.
6	Query options	<ul style="list-style-type: none"> • Filter: Opens the Query builder side panel to filter components. • (Clear) Filter: Clears all column filters. • CBS tree: Opens the CBS tree to filter by CBS. See CBS tree for more information. • AWP filter: Filter associated work packages to quickly find components associated with the selected work packages • Clear CBS and user queries: Clears all filters from the Query builder and the CBS tree.
7	Components	Shows components in a table according to the applied query and filters.
8	Results and selection counts	Shows the counts of results and selected components. Choose whether to view selected components or clear your selection

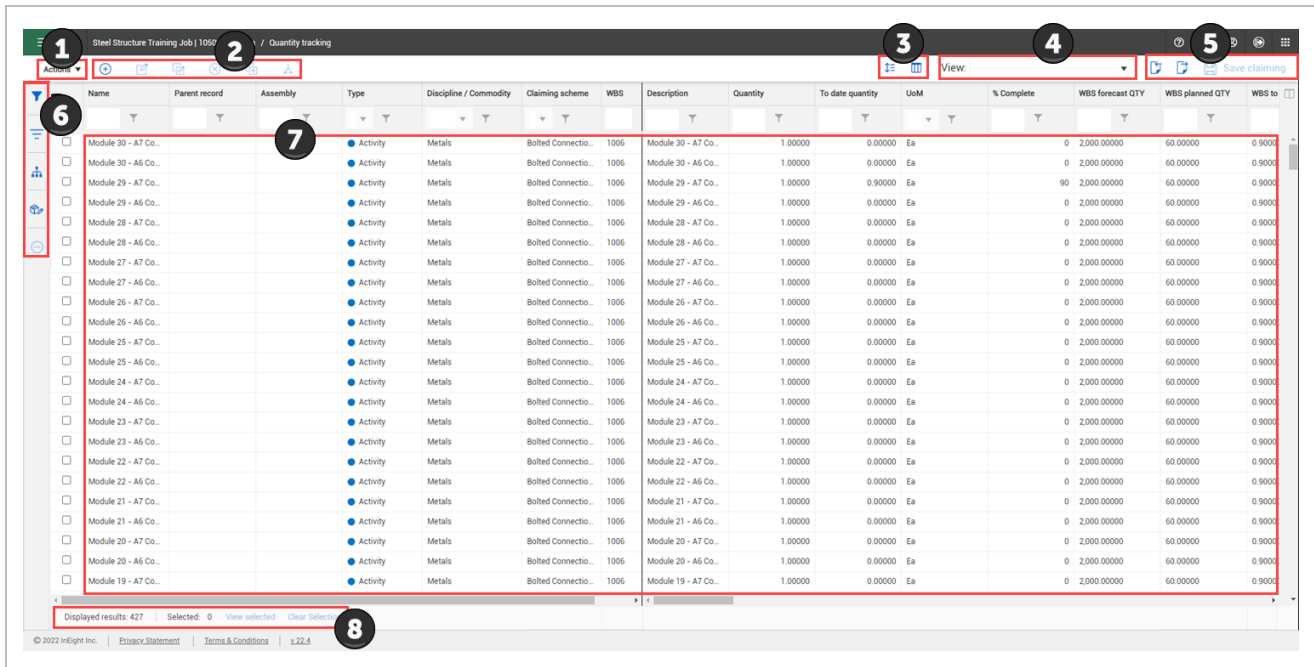

2.1.1 Standard Grid vs Data Block View

The Components page has two separate views: Standard Grid view and Data Block view. By default, the Components page opens in the Data Block view.

2.1.1.1 Standard Grid view

The Standard Grid view offers a traditional spreadsheet look with rows and columns.

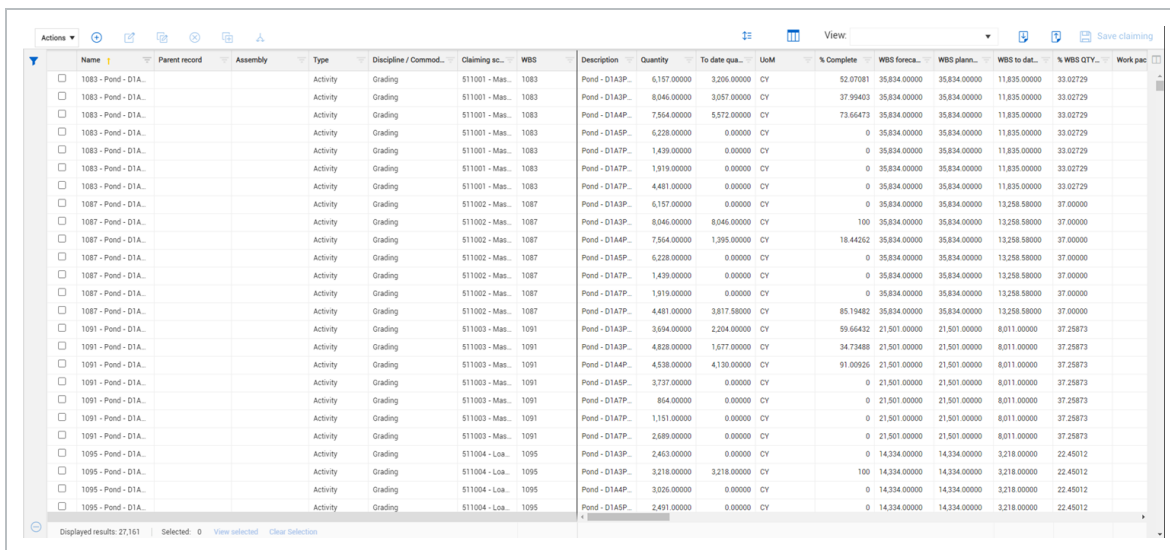

2.1.1.2 Data Block view

The Data Block view groups columns for a cleaner viewing experience focused on claiming. Data Blocks are covered in more detail in the Data Blocks topic.

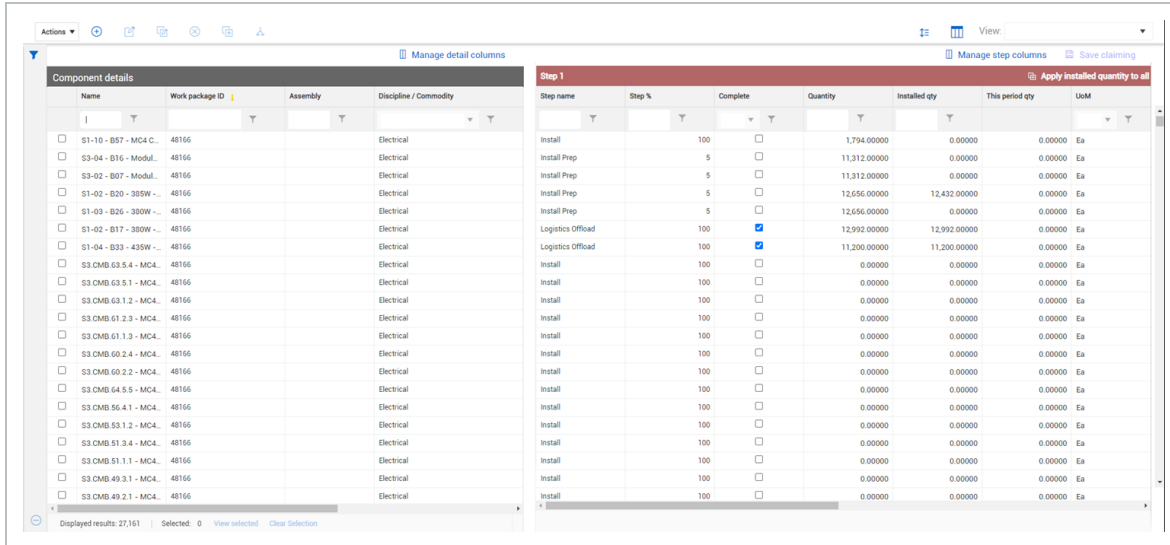

Easily switch between the two views by clicking the **View as** button on the toolbar.

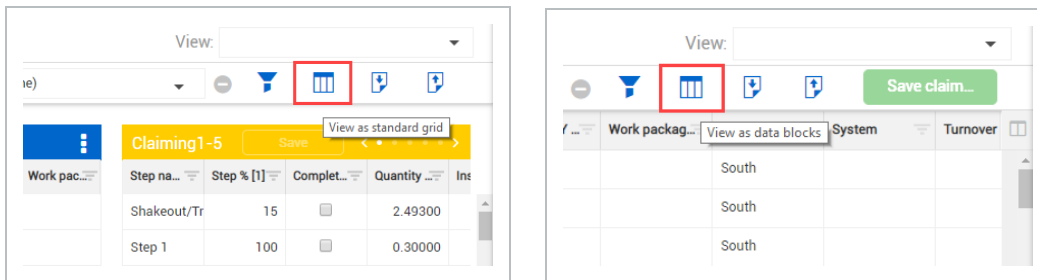

2.1.2 URL Filtering

Custom URLs can be generated from a source program, which can be shared as a direct link to Quantity tracking that filters to a specific WBS code.

The exact URL depends on your organization setup but the URL ends with *AppPlan/QuantityPlan/QuantityPlanLaunch?projectId=[ProjectID]&WBSPhaseCode=[WBS]*.

When the URL is accessed, the grid shows with the applied filters and the URL returns to its default value for the Plan Quantity tracking page. The component edit slide-out shows the matching records.

The screenshot shows a web browser window with the URL: `https://ineightsuite-qa-2312.hds.ineight.com/AppPlan/QuantityPlan/QuantityPlanLaunch?projectId=11095&componentname=9086&percentagecomplete=89.666`. The browser address bar highlights the query string parameters. Below the browser, the application interface displays a table with columns: Step name, Step %, Complete, Quantity, and Install. The table contains one row for 'Step 1' with values: Step name: Step 1, Step %: 100, Complete: , Quantity: 1,500.00000, and Install: . To the right of the table is a panel titled 'Edit activity component' with tabs for 'CLAIMING' and 'CLAIMING HISTORY'. The 'CLAIMING' tab is active, showing a table with columns: Step, % CL., Com., Date, and Qu. The table contains one row for 'Step 1' with values: Step: Step 1, % CL.: 100, Com.: , Date: (empty), and Qu: 1,5K. Below the table are input fields for 'Approver', 'Executor', and 'Notes'.

The system will filter the following columns which can be combined when creating a custom URL string:

- `projectId` (required)
- `componentname`
- `scheduleofvaluesitemid`
- `wbsphasecode`
- `area`
- `segment`
- `system`
- `subsystem`
- `turnover`
- `percentagecomplete`

2.2 COLUMNS

Customize columns according to your preferences. Changes you make to the placement of your columns will be retained the next time you access any page you have customized.

2.2.1 Move Columns

Drag and drop to move a column from one place to another to customize your view.

Move Columns

1. In the Standard Grid view of the Quantity Tracking module, click on and hold a column header.

	Name	Parent record	Assembly	Type	Discipline / Commod...	Claiming sc...	WBS	Description
<input type="checkbox"/>	Cross Brace Assem...		Cross Brace Assem...	Assembly				
<input type="checkbox"/>	Module 30 - A7 Co...			Activity	Metals	Bolted Conne...	1006	Module 30 - A...
<input type="checkbox"/>	Module 30 - A6 Co...			Activity	Metals	Bolted Conne...	1006	Module 30 - A...
<input type="checkbox"/>	Module 29 - A7 Co...			Activity	Metals	Bolted Conne...	1006	Module 29 - A...
<input type="checkbox"/>	Module 29 - A6 Co...			Activity	Metals	Bolted Conne...	1006	Module 29 - A...

2. Drag and drop the column in a new location.

	Name	Parent record	Assembly	Type	Discipline / Commod...	Claiming sc...	WBS	Description
<input type="checkbox"/>	Cross Brace Assem...		Cross Brace Assem...	Assembly				
<input type="checkbox"/>	Module 30 - A7 Co...			Activity	Metals	Bolted Conne...	1006	Module 30 - A...
<input type="checkbox"/>	Module 30 - A6 Co...			Activity	Metals	Bolted Conne...	1006	Module 30 - A...
<input type="checkbox"/>	Module 29 - A7 Co...			Activity	Metals	Bolted Conne...	1006	Module 29 - A...

2.2.2 Add and Remove Columns

Add or remove columns to customize your view and work more efficiently when in the Standard Grid view.

Add Additional Columns

1. From the Standard Grid view, select the **Column Chooser icon** to open a pop-up window where you can search for and select columns.

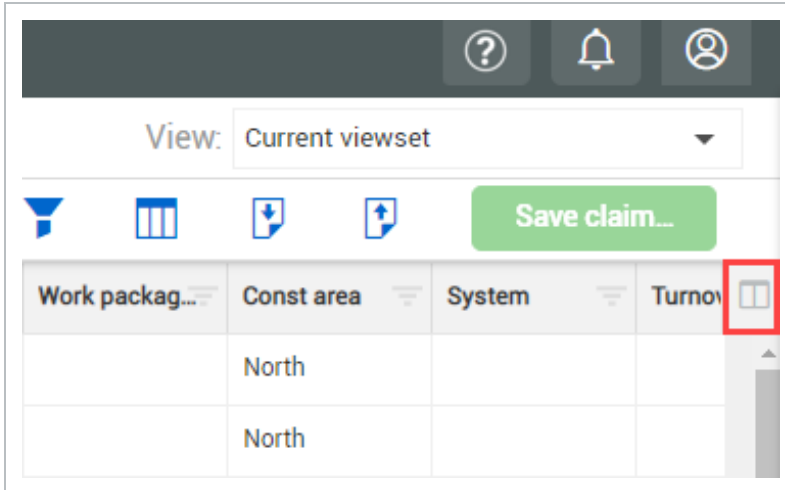

2. In the selected columns list on the right, highlight all columns. To do this, select the first item in the list, press and hold the Shift key, scroll down the list, and select the last item in the list. Then, select the **left pointing arrow**.

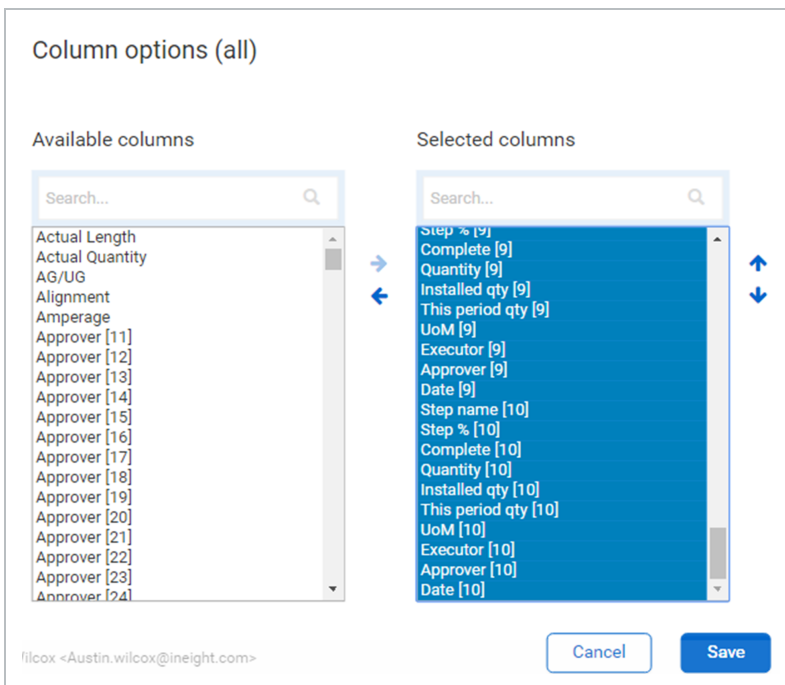

3. In the Available columns list on the left, type a column name in the search bar or use the scroll bar to find a column by name. Select a column from the **Available columns list**.

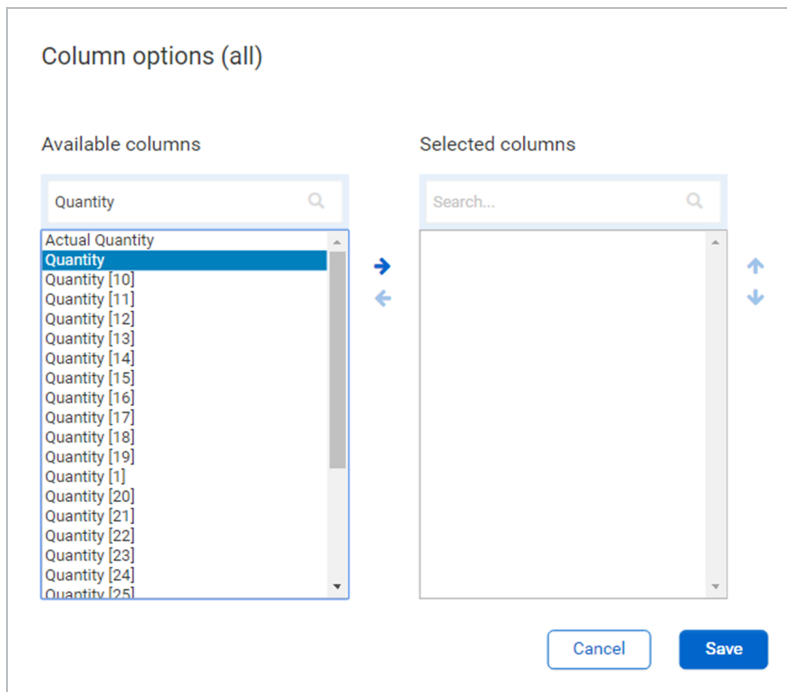

A yellow caution icon shows when a column is unavailable.

4. Select the **right facing arrow**.
5. Repeat steps three and four as needed for your project.

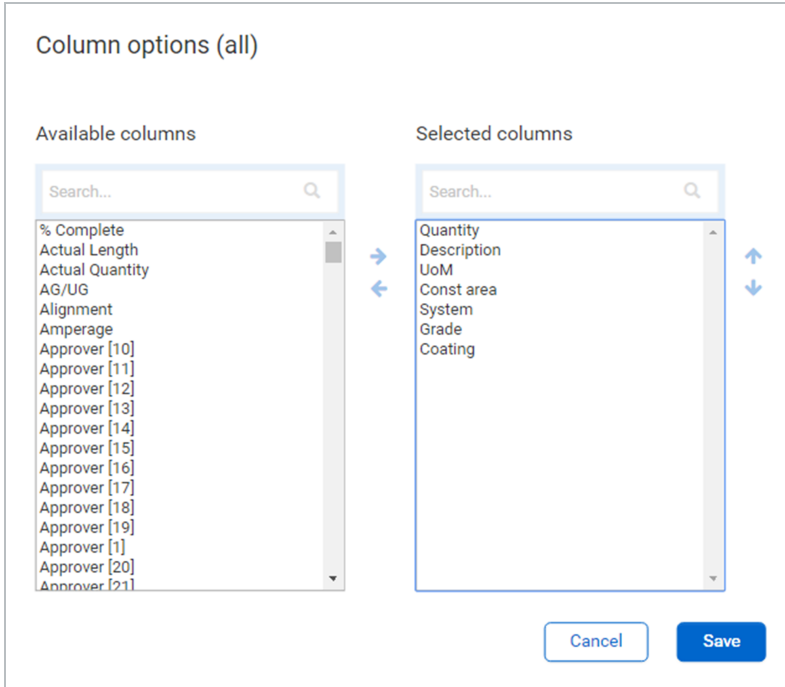

6. Click **Save**.

2.2.3 Sort Columns

Sort in ascending or descending (both for alpha and numeric fields) order on any column by clicking one time on the column header.

Sort Columns

1. In the Standard Grid view of the Components page, click on any column header to sort the column in ascending order.

Discipline / Commodity	Claiming sch...	Quantity ↑	Description	To date quan...
Metals	Erect Steel - L...	0.10000	Module 1 - E2...	0.00000

- Notice the yellow up arrow designating you are sorting in ascending order
2. Click on a column header again (a second time) and the column will filter in descending order.

Discipline / Commodity	Claiming sch...	Quantity ↓	Description	To date quan...
Metals	Bolted Conne...	1.00000	Module 1 - A6...	0.00000

- Notice the yellow arrow is now pointing down
3. Click the same column header a third time to remove the applied sorting feature.

2.2.4 Filter Columns

Filter columns as a way to see relevant information pertaining to your specific needs.

Filter Columns

1. In standard or data block view, type your filtering criteria in the text box of any column header. A drop-down list shows matching criteria.

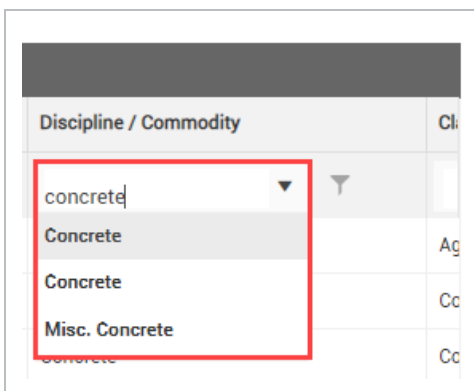

2. Select a value from the drop-down list or press **Enter**.
3. Optionally, click the **Filter** icon to select a different operator.

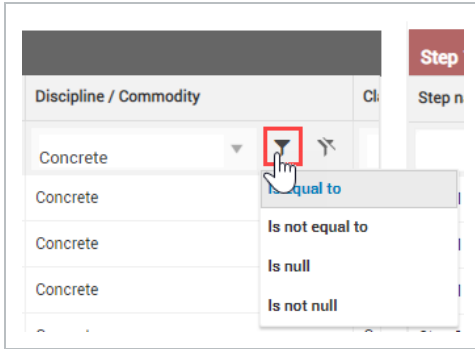

4. Click the **Clear** icon to remove the filter.

You can apply filters to multiple columns at the same time.

To clear all column filters at the same time, click the **Clear applied filters** icon on the left of the Quantity tracking page.

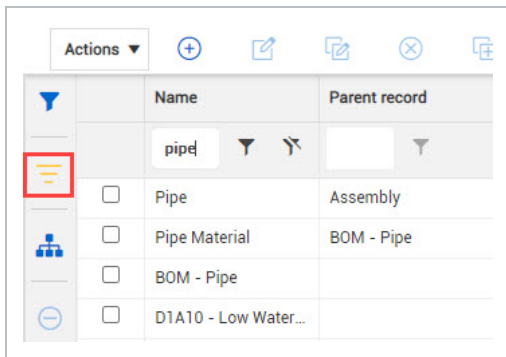

If you hover over the icon, a word bubble shows the current applied column filters.

2.2.5 Saved Filters

Save a specific filter to save time later and share with your team.

Create a Saved Filter

1. On the Components page, select the **Filter icon**.

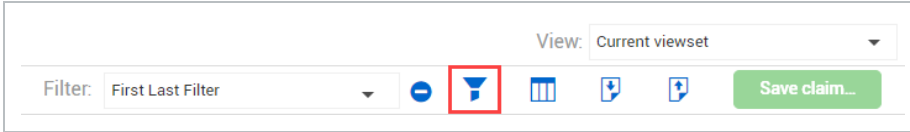

2. On the resulting left slide out panel, select a column from the drop-down list in the column field.

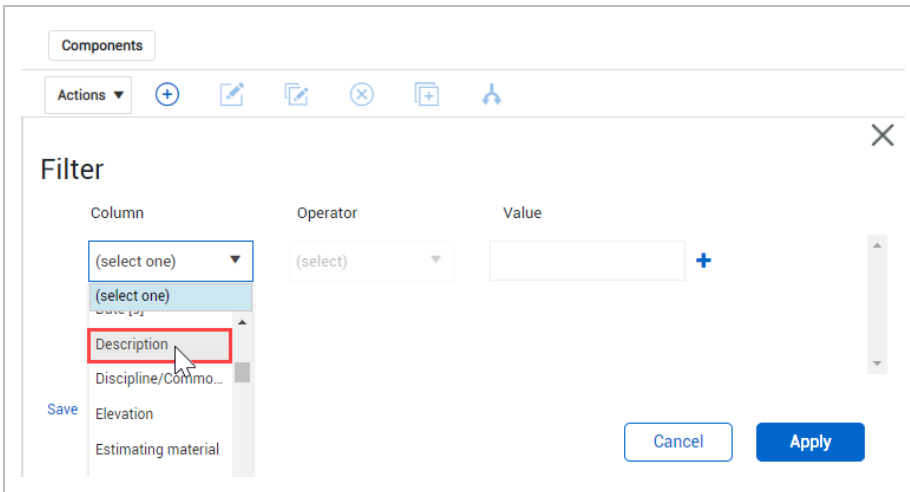

3. From the operator field, select an option from the drop-down list.

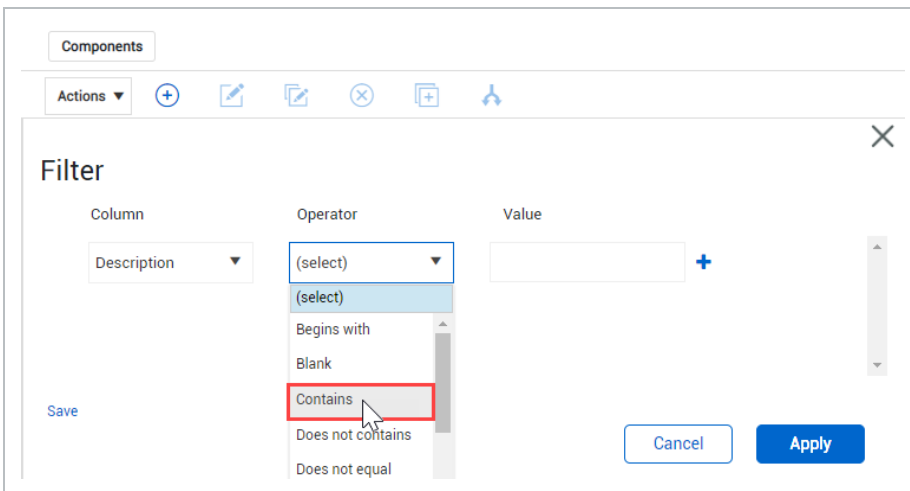

4. Enter a value in the Value field.

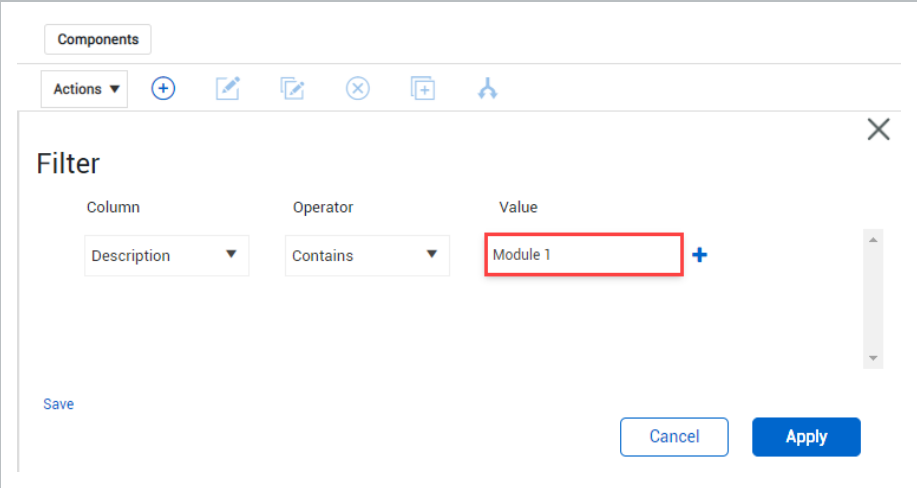

5. Click **Save** in the bottom left of the box.

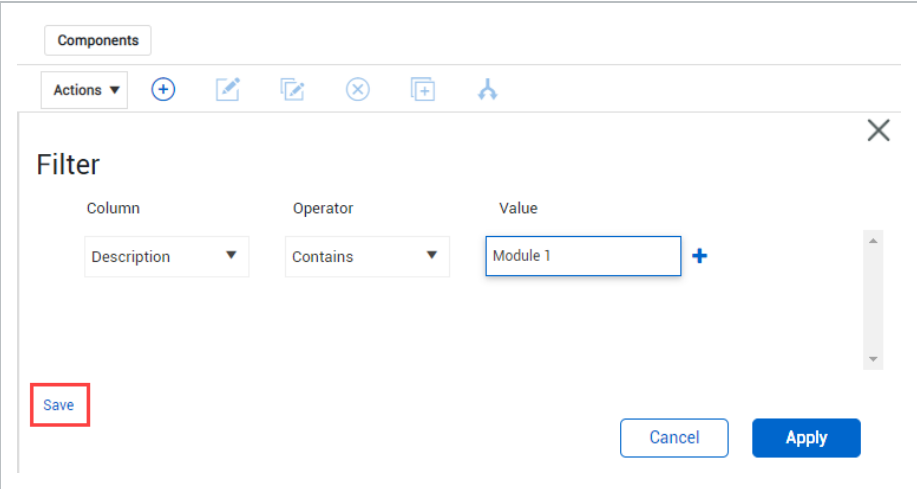

6. Change the filter name.

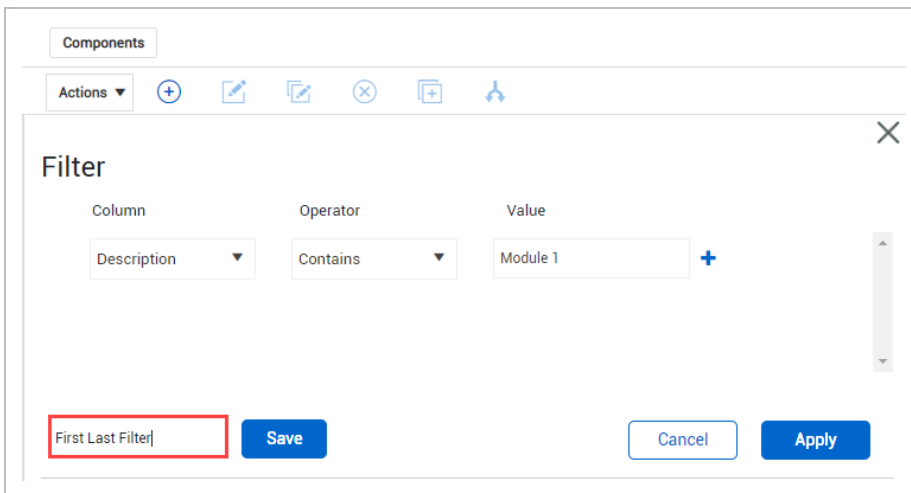

- 7. Click **Save**. You now have a saved filter.
- 8. Click **Apply** to apply your filter.

You can also share pre-defined filters with your team.

2.3 VIEWSETS

You can create a saved view of your page so that you can always revert to it. This saved view is called a viewset.

Create a Viewset

1. Select the **View** drop-down arrow to save your current view.

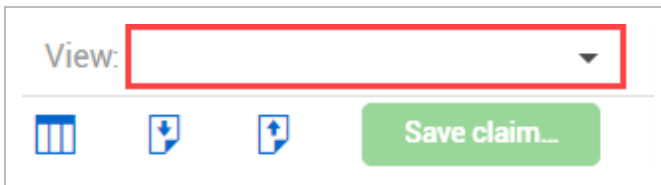

2. Select **Save current viewset as** from the viewset drop-down list.

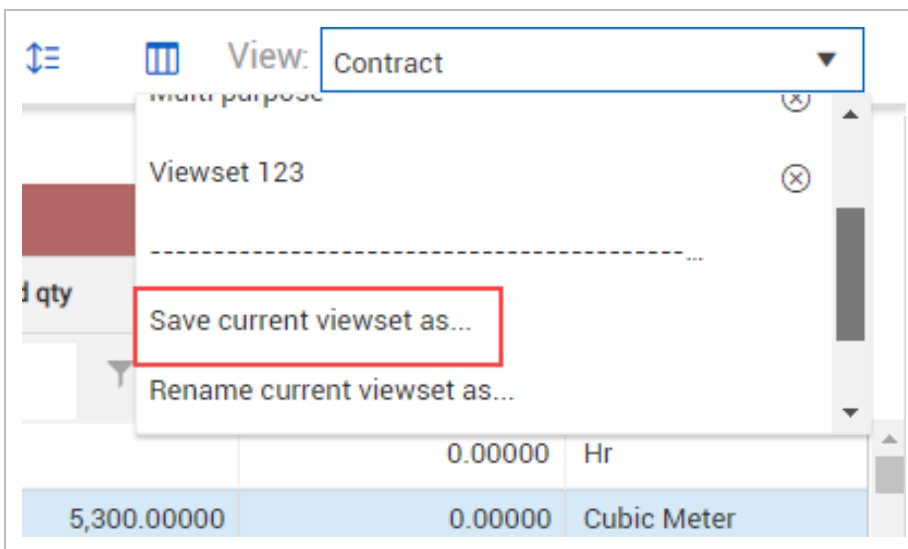

3. In the dialog box, type a name.

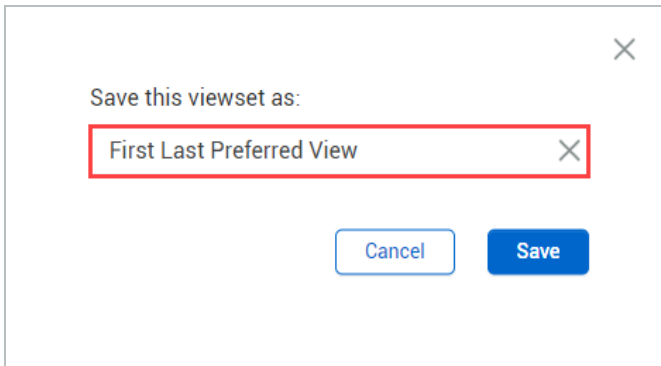

4. Click **Save**.

When making changes to the quantity tracking layout, you will see an **unsaved view** option in the view menu. This lets you know changes have not been saved.

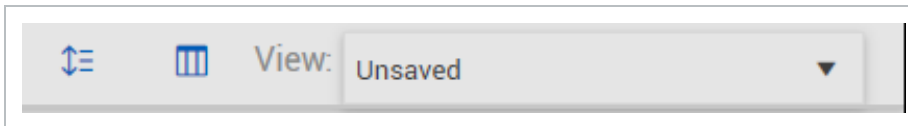

Each viewset is user-specific. However, viewsets do not carry over from the Standard Grid view to the Data Block view. You have to create your viewsets for both the Standard Grid and Data Block views.

2.3.1 Send a viewset

Certain permissions are needed to send viewsets to roles.

You can send views to all users that have a certain role. You can also send it to specific projects or full organizations. To send to a project, you must be a user on that project or in that organization.

Send a viewset

1. Open the viewset you want to share.
2. Open the View drop-down list, and then select **Send current view**.
3. Select **Users** or **Projects** from the drop-down list, and then search by user name or project. You can add multiple users and projects.

When you share a view with another project, any project-specific fields are not shown in the receiving project. You can select the Share view as global template option.

Send view (Demo 2312) to

Users

Search for a user

Send to

Users

No users selected

Projects

No projects selected

 Remove all

Share view as global template.

Cancel

Click **Send**. A notification is sent to the selected users and the viewset is available in their drop-down list, along with the sender's name and the date when the viewset was sent.

2.3.2 Delete a viewset

Delete a viewset by selecting the delete icon in the drop-down list directly in the viewset.

Delete a viewset

1. Open the View drop-down list, and then select the **Delete** icon.

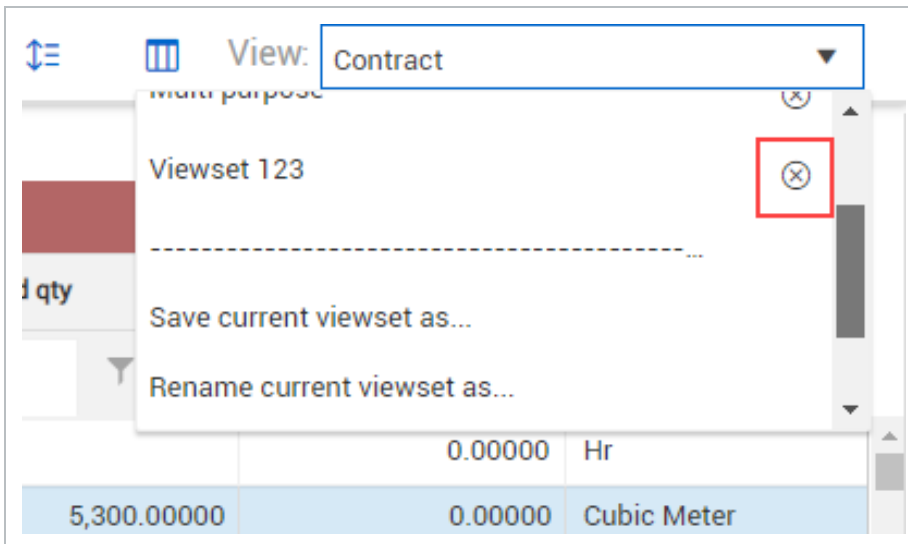

2. Select **Yes** to delete the viewset.

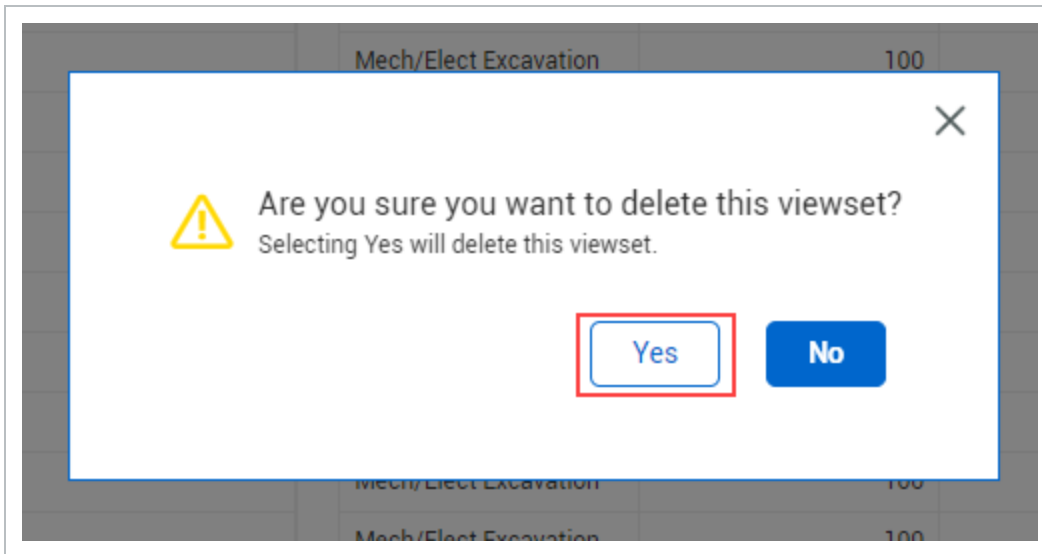

2.4 DATA BLOCKS

Each data block is a set of columns grouped together based on categories of information that let you focus on claiming. Data blocks help you to organize and manage all the columns on a page.

The information in each data block is displayed in a grid-like format, maintaining a spreadsheet look and feel.

The screenshot displays two data blocks side-by-side. The left block, titled 'Component details', is a table with columns: Name, Work package ID, Assembly, and Discipline / Commodity. It lists various components with checkboxes and dropdown menus. The right block, titled 'Step 1', is a table with columns: Step name, Step %, Complete, Quantity, Installed qty, This period qty, and Unit. It shows a list of steps with checkboxes for completion and numerical values for quantities.

2.4.1 Component Details Data Block

The Component details data block on the left side of the page shows basic information about components so you can easily identify, sort, and filter them while claiming.

Component details shows a maximum of seven columns, which limits how much you have to scroll left and right. The Name column is required. You can choose the other six columns.

To choose which columns are shown, click **Manage detail columns**.

2.4.2 Step Data Blocks

The Step data blocks on the right side of the page show claiming information for each step. You can enter quantities and mark steps complete directly in the data blocks.

You can choose which steps and columns are shown in the Step data blocks. If you want to claim only for a certain step for all components, you can choose only that step to be visible.

To choose what steps and columns are shown, click **Manage step columns**.

You can use the Apply installed quantity to all button at the top of a step data block to apply an installed quantity to all components in your current view.

You can only apply installed quantity up to 50 components at a time, so you must filter your view first to show only the components you want to apply the installed quantity to.

When you click **Apply installed quantity to all**, you can choose to apply an amount or a percentage. After you enter a value, click **Apply**.

If you apply a certain amount that exceeds a component's remaining quantity, all the remaining quantity is installed.

The screenshot shows a software interface with a table and a dialog box. The table has two columns: 'Quantity' and 'Installed qty'. The 'Quantity' column contains the value '20,380.00000' for five rows. The 'Installed qty' column contains the value '0.00000' for five rows. Above the table, there are buttons for 'Manage step columns' and 'Save claiming', and a red button labeled 'Apply installed quantity to all'. A dialog box is open over the table, showing two radio buttons: 'Installed quantity(or maximum remaining)' and 'Installed quantity %'. The second option is selected. Below the radio buttons, there is a text input field containing the value '75'. At the bottom of the dialog, there are 'Cancel' and 'Apply' buttons.

After you apply the installed quantity, the changes are flagged as pending in each row until you click **Save claiming**.

2.5 QUERY BUILDER

The Query builder lets you build queries with multiple conditions to filter the entire table of components. You can add, edit, delete, and share queries with others.

To open the Queries slide-out panel, click the **Query** icon on the left side of the page.

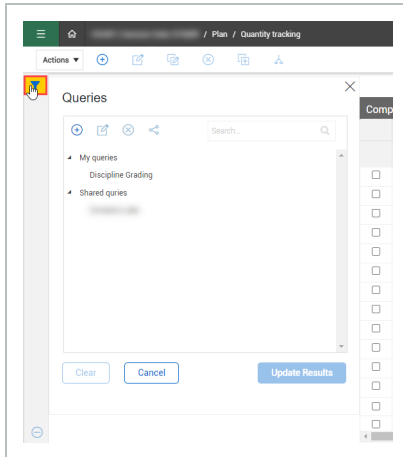

2.5.1 Add a Query

A query is made up of conditions that are made up of columns, values, and operators that connect the columns and operators. Multiple conditions can be grouped as And or Or statements.

The following step by step shows you how to add a query, apply it, and then save it for future use.

Add a Query

1. Click the **Query** icon on the left side of the page to open the Queries slide-out panel.
2. Click the **Add** icon. The Query builder opens.
3. Select a column and operator from the drop-down lists.
4. Enter a value that you want to filter the column for.
5. Optionally, click the **Add** icon to add more conditions, and then click **And** or **Or** to change how the conditions are grouped.
6. Click **Apply** to update results immediately.

7. Click **Save query**.

2.6 CBS TREE

The CBS tree is a filter in Quantity tracking that shows the InEight Control WBS Structure, which helps you filter components to the CBS you want without jumping between Plan and Control.

To open the CBS tree in Quantity tracking, click the **CBS tree** icon on the left side of the page. The CBS tree slide-out panel opens.

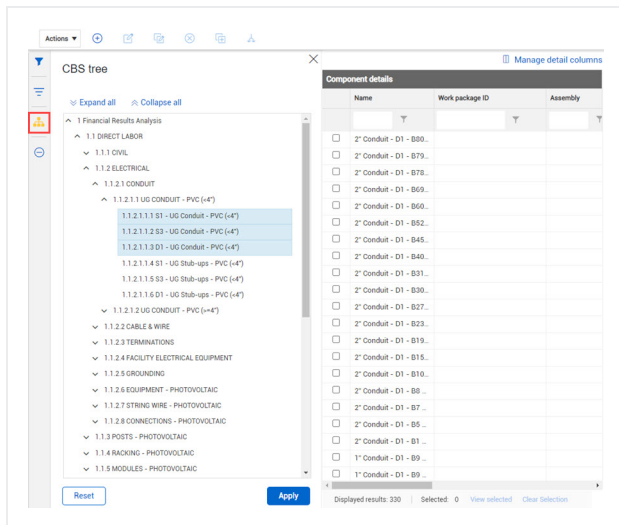

You can expand and collapse levels of the CBS tree using the arrow icons or the Expand all and Collapse all buttons. To select CBS items to filter for, click one or more CBS items, and then click **Apply**. The components list refreshes to show only components that match the selected CBS items.

To clear the CBS query, click either **Reset** in the CBS tree slide-out panel or click the **Clear CBS and user queries** icon to the left of the panel.

2.7 AWP FILTER

The AWP filter lets you filter associated work packages which helps you can quickly find the components associated with the selected work packages.

To filter components by work package, click the **AWP filter** icon on the left side of the Quantity tracking page. The AWP filter slide-out panel opens.

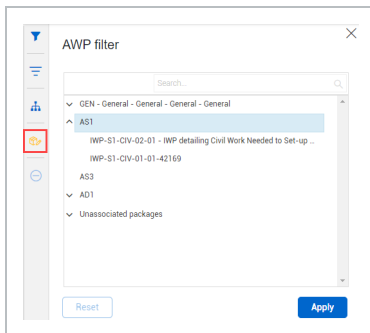

Select one or more work packages, and then click **Apply** to filter the list of components.

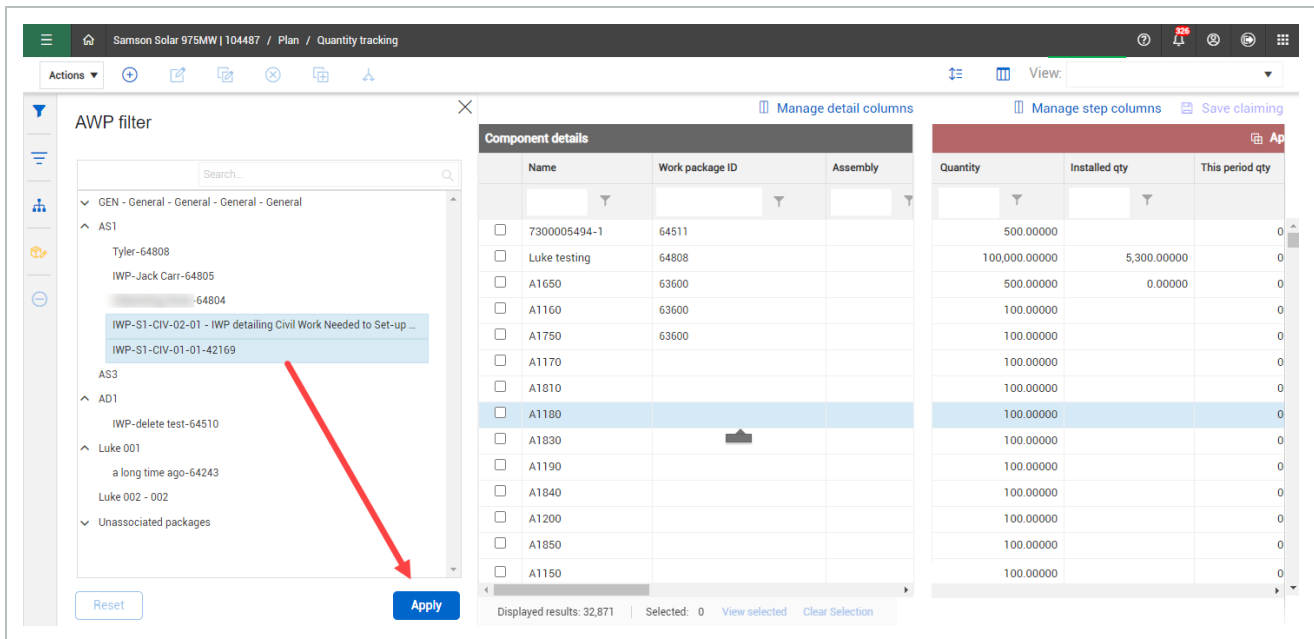

All the components associated to the selected work packages show.

Component details					
Name	Work package ID	Assembly	Discipline / Commodity	Claiming sche	
<input type="checkbox"/>	Sams... 42169		Operational Support	301002 - Site S	
<input type="checkbox"/>	Sams... 42169		Operational Support	301002 - Site S	
<input type="checkbox"/>	Sams... 42169		Operational Support	301002 - Site S	
<input type="checkbox"/>	Sams... 42169		Operational Support	301002 - Site S	
<input type="checkbox"/>	Sams... 42169		Civil Utilities	521011 - Utility	
<input type="checkbox"/>	Sams... 42169		Civil Utilities	521011 - Utility	
<input type="checkbox"/>	Sams... 42169		Civil Utilities	521011 - Utility	
<input type="checkbox"/>	Sams... 42170		Aggregates and Paving	530004 - Insta	
<input type="checkbox"/>	Sams... 42170		Aggregates and Paving	530004 - Insta	
<input type="checkbox"/>	Sams... 42170		Aggregates and Paving	530004 - Insta	
<input type="checkbox"/>	Sams... 42170		Aggregates and Paving	530004 - Insta	

Step 1				
Step name	Complete	Installed qty	This period qty	UoM
Install	<input checked="" type="checkbox"/>	3,000.00000	0.00000	SY
Install	<input checked="" type="checkbox"/>	3,000.00000	0.00000	SY
Install	<input checked="" type="checkbox"/>	3,000.00000	0.00000	SY
Install	<input checked="" type="checkbox"/>	3,000.00000	0.00000	SY
Excavate Trench	<input checked="" type="checkbox"/>	60.00000	0.00000	LF
Excavate Trench	<input checked="" type="checkbox"/>	60.00000	0.00000	LF
Excavate Trench	<input checked="" type="checkbox"/>	80.00000	0.00000	LF
Step 1	<input checked="" type="checkbox"/>	51,325.80000	0.00000	Ton
Step 1	<input checked="" type="checkbox"/>	42,170.14000	0.00000	Ton
Step 1	<input checked="" type="checkbox"/>	51,150.80000	0.00000	Ton
Step 1	<input checked="" type="checkbox"/>	26,207.00000	0.00000	Ton

Select **Reset** or **Clear CBS and user queries** to clear or reset the applied filter.

Steel Structure Training Job | 105091 / Plan / Quantity tracking

Actions [Icons]

AWP filter

- North
 - CWP- North Area Steel Erection-12
 - South
- Unassociated packages
 - IWP-test-9
 - IWP-mn,n-5
 - CWP-hkh-4

Clear CBS and user queries 1-7

Reset
Apply

Component details

Name	Work package ID
<input type="checkbox"/> 1069	5
<input type="checkbox"/> 1085	5

Displayed results: 2 | Selected: 0 [View selecte](#)

This page intentionally left blank.

CHAPTER 3 – CLAIMING SCHEMES

3.1 WHAT IS A CLAIMING SCHEME?

A claiming scheme is a formula used to record partial progress of installed quantities. The installation sequence is broken down by steps or milestones and assigned a completion percentage based on the level of effort to complete each step. This allows you to progressively track progress as phases of construction are completed on a daily or weekly basis.

Scenario

Imagine you are a field engineer responsible for tracking completion progress for the installation of structural steel for your assigned module. Work includes shaking out and transporting steel to the work area, erecting and bolting up steel members and final torqueing of bolts to the required specification. These steps happen over a period of time, and you need to report percent complete as work is performed. Predefined claiming schemes help you accomplish this without having to wait until the very end when all steps are complete.

Why would you not want to wait until all work steps are complete to claim an activity?

The answer: Delayed reporting of progress can hide issues and cause more impactful schedule and budget concerns if gone unnoticed. Short interval claiming via claiming schemes provides up-to-date reporting at all times.

3.1.1 What is the purpose?

Quantity tracking/claiming is the backbone for accurate cost reporting. Completed quantities drive your earned budget, overall percent complete, and forecasted cost at completion. It is imperative to have accurate completion percentages at short intervals (daily or weekly) to quickly recognize negative trends and react in a timely manner. Claiming schemes are designed to methodically claim portions of work that are completed within shorter intervals than the overall scope of work.

For example, referring to the scenario above:

You can predefine the percent complete of each step required to complete the structural steel installation, including final quality verification.

- *Step 1: Shake out / Transport*
- *Step 2: Erect / Bolt up*

- *Step 3: Final Torque*
- *Step 4: Quality Verification*

The percent complete assigned to each step should be based on the level of effort required to complete that step.

3.1.2 Setting up a Claiming Scheme

Claiming schemes are managed in the Quantity Tracking section of InEight Plan. They are created for both construction activities and commodities. Claiming schemes are organized by discipline and commodity type respectively. All disciplines and commodity types are preloaded with a default claiming scheme containing one step for 100%.

To add, edit, or delete disciplines and commodities, go to Master data libraries > **Disciplines and commodities**. On this page, you can only edit or delete one discipline or commodity at a time and only if the discipline or commodity is not in use.

You can edit and add claiming schemes under the discipline or commodity types. You can associate a schedule group and an activity ID format to the claiming scheme.

To manage schedule groups as an administrator, use the second level menu at the top of your screen to navigate to **Settings**. Then, select **Plan** from the menu on the left. Next, choose the

Quantity Tracking tab and use the Maintain schedule group values table.

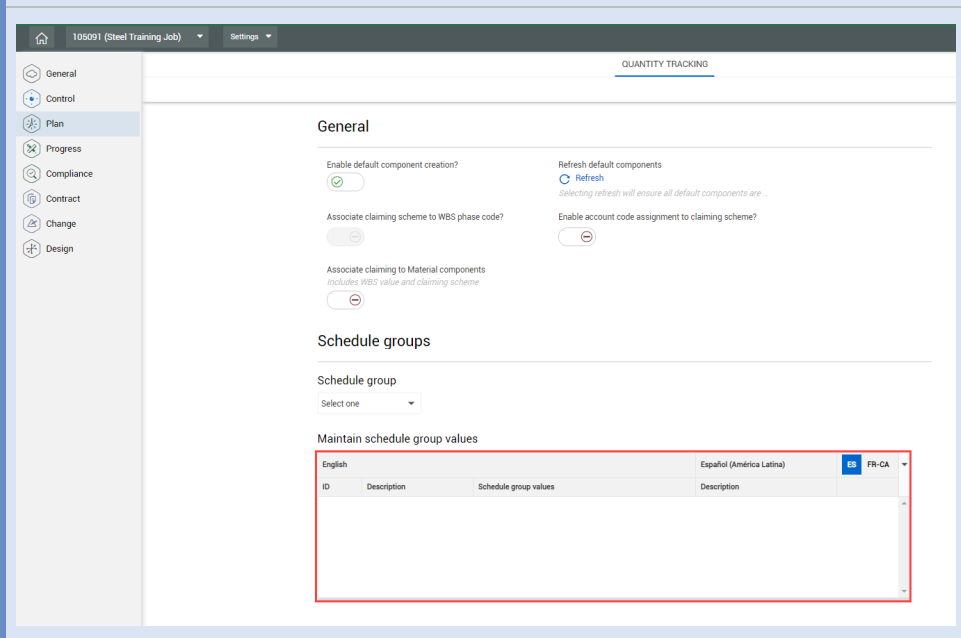

Once a claiming scheme is created, you can assign it to specific WBS phase code(s) or component(s) depending on the project set up.

When creating claiming schemes, aim for 3-5 steps. As a general rule, each step should be able to be completed for one component within one week.

The following table displays an example of how a claiming scheme could be set up for structural steel installation.

Structural Steel Claiming Scheme		
Stage	Title	Percent Claimed
1	Shakeout / Transport Steel to Area	15%
2	Erect / Bolt Up	45%
3	Final Torque	30%
4	QC Verification	10%

A Claiming Scheme must add up to 100%.

To associate schedule groups or activity IDs when creating or editing a claiming scheme, select the cells under the **Schedule group** or **Activity ID format** columns and select from the drop-down menus.

Here is an example of what the Structural Steel Claiming Scheme would look like in Plan:

Edit Place/Finish/Cure

Name
Place/Finish/Cure

Step name	Rule type	% claiming	Schedule group	Activity ID format
Place/Finish/Cure	Construction Step	95	Install	Discipline/Area
⊗ Verify/Document	Quality Step	5	Verification & Documentation	AccountCode/System/Turnov...

+ Add step Total: 100%

Cancel Save

By default, when you assign a claiming scheme to a component, the steps automatically inherit the same quantity and unit of measure as the component. However, depending on the component and situation, it may be necessary to change the unit of measure and quantity per step. This can be done and will be covered in greater detail in *Lesson 4 – Component Management*.

3.1.3 Claiming Scheme Solutions

Claiming schemes:

- Allow you to track your claiming in one central location
- Reduce your need for individual side spreadsheets
- Allow for drill down transparency to see what specific work has been claimed as complete

- Keep claiming consistent with a clear breakout of quantities reserved for specific activities
- Communicate actual work steps to your foreman in the field when completing their plan

3.1.4 Account Code Assignment

You can also assign account codes to claiming schemes. Account codes can be used to further categorize and standardize claiming schemes for integration with other applications. Below shows how claiming schemes are organized by discipline in Plan, with account codes assigned:

Through the **Project Settings**, you can turn on or off the **Account Code Assignment**. If turned off, the Account Code Assignment column will be un-selectable.

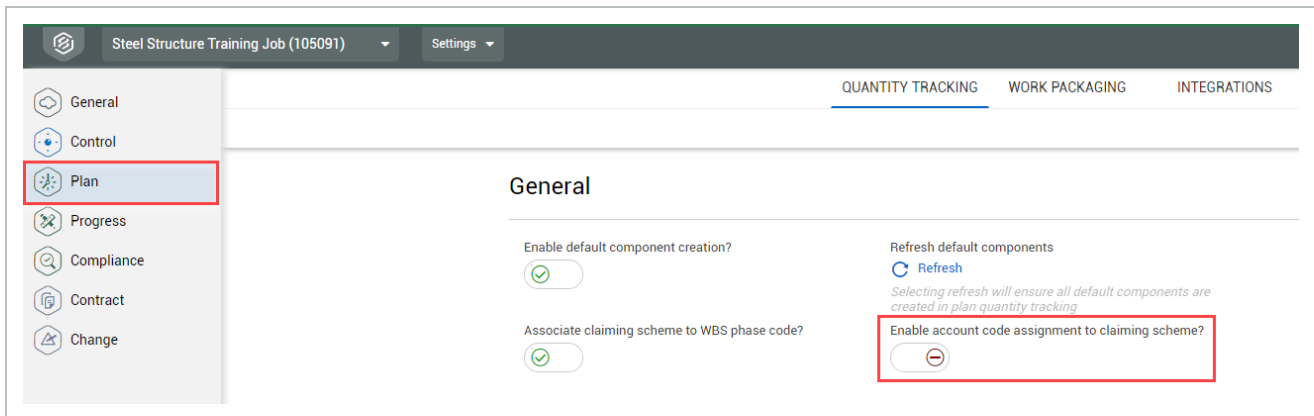

With Account Code Assignment to Claiming Scheme **enabled**:

Discipline/claiming scheme	WBS assignment	Default	Account code assignment
Aggregates and Paving	WBS Assigned	☑	Account codes assigned
Agg. and Paving - Gen. Claiming 95/5	WBS Assigned		Account codes assigned
Building	Assign now	☑	Assign account code
Building - Gen. Claiming 95/5	Assign now	☑	Account codes assigned

With Account Code Assignment to Claiming Scheme **disabled**:

Discipline/claiming scheme	WBS assignment	Default	Account code assignment
Aggregates and Paving	Assign now		Assign account code
Building	Assign now		Assign account code
Bulk Commodities	Assign now		Assign account code
Change Orders, Contract Allowances and Back charges	Assign now		Assign account code

As you can see, the Assign Account Code column is un-selectable.

3.2 CLAIMING SCHEME CREATION

You will now create a claiming scheme in Plan for the erect steel code you created for your module during the InEight Control lesson. By default, the Plan application has a claiming scheme already created for each discipline. These default claiming schemes are all one step claiming schemes and can be modified as needed.

The screenshot shows the 'Edit Metals' interface. At the top, there is a 'Name' field containing 'Metals'. Below this is a table with the following columns: 'Step name', 'Rule type', '% claiming', 'Schedule group', and 'Activity ID format'. The table contains one row: 'Step 1', with a '% claiming' value of 100. At the bottom of the table, there is a summary row showing 'Total: 100%'. Below the table is an 'Add step' button with a plus icon. At the bottom right of the form are 'Cancel' and 'Save' buttons.

In most cases, you will need multiple claiming schemes for a single discipline. For example, in structural work you will need a different claiming scheme for bolted connections than you will need for erecting light steel. Plan allows for the creation of multiple claiming schemes under the discipline of Metals.

<input type="checkbox"/>	Job Related Overhead	Assign now
<input type="checkbox"/>	Mechanical Equipment	Assign now
<input type="checkbox"/>	^ Metals	Assign now
<input type="checkbox"/>	Bolted Connections	WBS Assigned
<input type="checkbox"/>	Erect Steel - Light	WBS Assigned
<input type="checkbox"/>	XXX Erect Steel - Heavy	WBS Assigned
<input type="checkbox"/>	Mining	Assign now

There is a parent-child relationship between the discipline claiming scheme and those added beneath it. Practice by creating a claiming scheme under the discipline that you created previously.

The following step by step walks you through how to create child-level claiming schemes.

Build a Claiming Scheme

1. Open your project and go to the **Quantity Tracking page**.

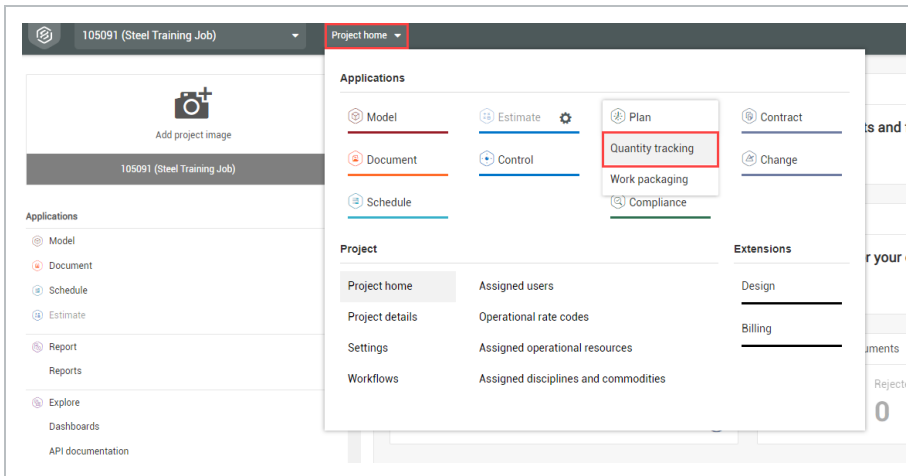

2. From the Actions drop-down menu, select **Manage claiming schemes**.

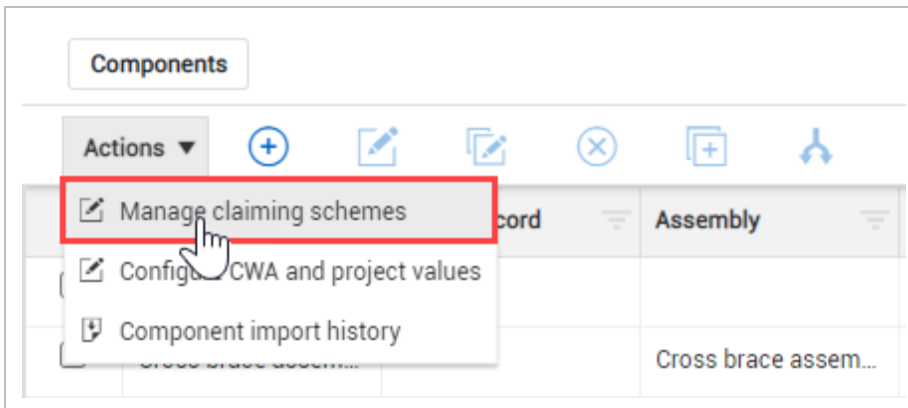

3. To place the claiming scheme in a discipline, click on the **check box** next that discipline in the Claiming Scheme list.
4. Click the **Add** icon on the left toolbar. You will now see a claiming scheme setup box.

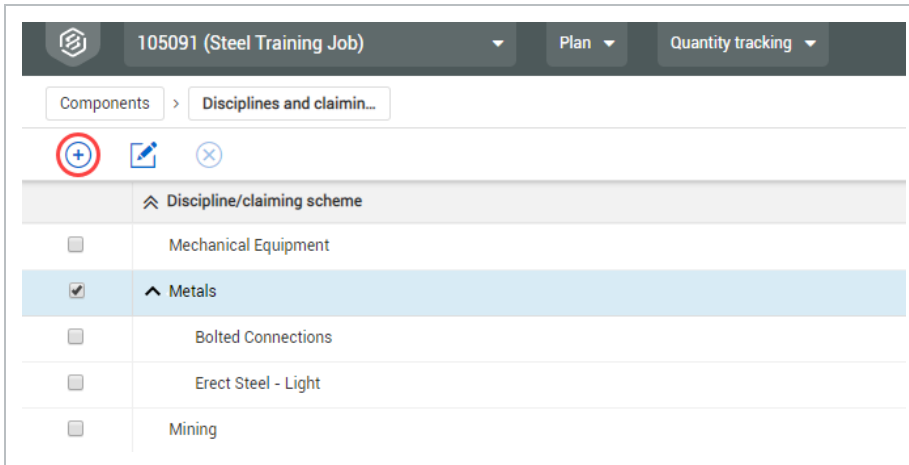

5. In the Name field, name your new claiming scheme.

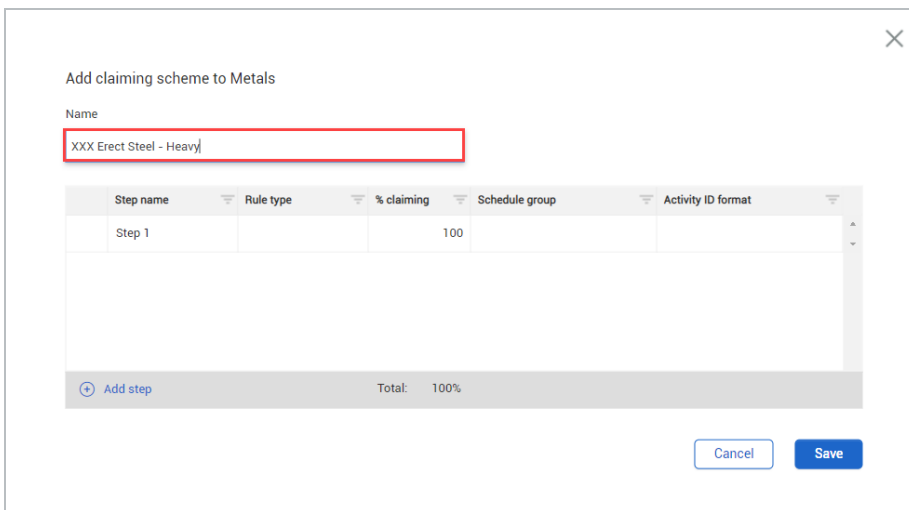

6. To add steps to your claiming scheme, click **Add Steps** .

Add claiming scheme to Metals

Name
XXX Erect Steel - Heavy

Step name	Rule type	% claiming	Schedule group	Activity ID format
Step 1		100		

+ Add step Total: 100%

Cancel Save

7. After creating those steps, rename them, add rule types and percentages.
- To associate schedule groups or activity IDs when creating or editing a claiming scheme, select the cells under the **Schedule group** or **Activity ID format** columns and select from the drop-down menus

Edit XXX Erect Steel - Heavy

Name
XXX Erect Steel - Heavy

Step name	Rule type	% claiming	Schedule group	Activity ID format
Shakeout/Transport	Construction Step	15		
⊗ Erect/Bolt Up	Construction Step	45		
⊗ Final Torque	Construction Step	40		

+ Add step Total: 100%

Cancel Save

Copy claiming schemes from other projects to bring over the associated account codes, schedule groups, and activity ID formats.

8. Click **Save**.

3.2.1 Import and Export

You can import and export claiming schemes between projects by using the Import and Export icons in the top right of the page.

The following Step by Step shows you how to import claiming schemes from another project.

Import Claiming Schemes

1. In the top right of the Disciplines and claiming schemes page, click the **Import** icon.
 - The Select a project to import claiming schemes dialog box is shown
2. Select a project from the list.

You can search for a project using the Search bar in the top right.

You can only import claiming schemes from one project at a time.

3. Click **Select**.

All of the project's claiming schemes are imported into your project.

There are two methods to export claiming schemes:

- Export all of the current project's claiming schemes to another project.
- Select specific claiming schemes and then export only those schemes.

The following Step by Step shows you how to export specific claiming schemes to another project.

Export Claiming Schemes

1. On the Disciplines and claiming schemes page, select the check boxes next to the claiming schemes you want to export.
2. Click the **Export** icon in the top right of the page.

- The Claiming scheme project export dialog box is shown

3. Select a project from the list.

You can search for a project using the Search bar in the top right.

You can only export claiming schemes to one project at a time.

4. Under Claiming schemes to send, choose **Selected claiming schemes**.

If you choose **All active claiming schemes**, your selections are ignored and all schemes are exported.

5. Click **Send**.

The selected claiming schemes are exported to the target project.

3.3 CLAIMING SCHEME MANAGEMENT

3.3.1 Assigning Claiming Schemes

Once you create a claiming scheme and it is ready to be used, the next step is to assign that claiming scheme. You can assign claiming schemes in two different ways:

- Option 1: Assign to WBS cost items
- Option 2: Assign to each component

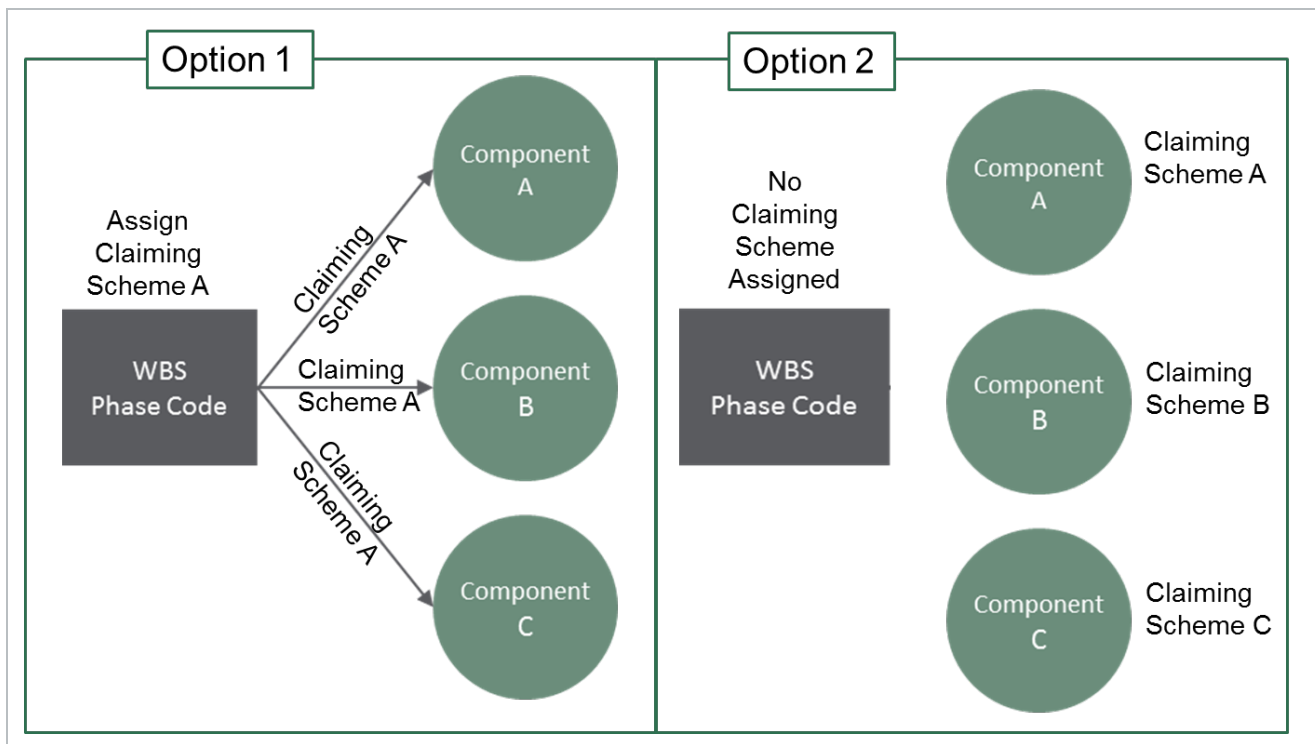

To assign claiming schemes at the component level, you must assign them to each component individually. If you assign a claiming scheme at the WBS level, then every component assigned to that WBS will inherit the same claiming scheme.

To change at the level at which your claiming schemes are assigned, navigate to the **Project Settings**.

When choosing to assign claiming schemes at a WBS level you must have a claiming scheme assigned to a WBS before you can add components with that WBS. If you choose to assign claiming schemes at a component level, you will not be able to assign any to a WBS.

The following step by step walks you through how to assign a WBS item to a claiming scheme.

Assign a WBS to a Claiming Scheme

In order to be able to assign a WBS to a claiming scheme, the Allow As-Built setting for that WBS line item in Control should either be "All" or "Quantities." This makes that WBS available for Plan.

1. From the Quantity Tracking page, select the **Actions** menu and choose **Manage claiming schemes** from the drop-down list.

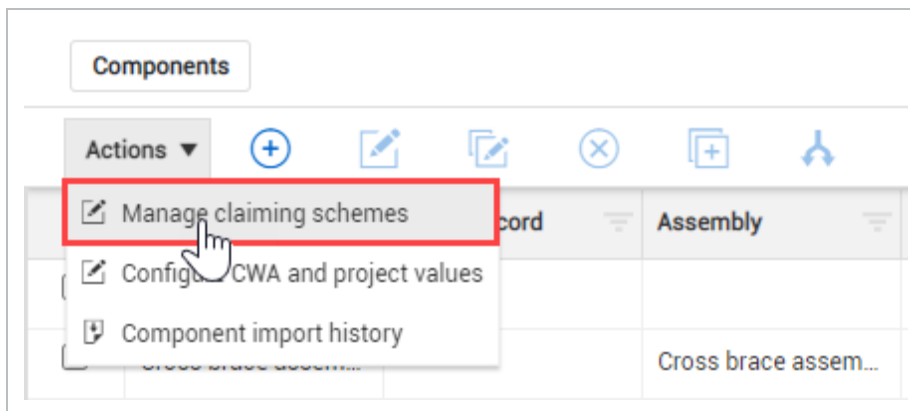

2. Click on the Disciplines and or Commodities. Multiple schemes can be selected.

You cannot assign a WBS or account code to the Contract discipline.

3. Click on the **Add** icon on the left toolbar.

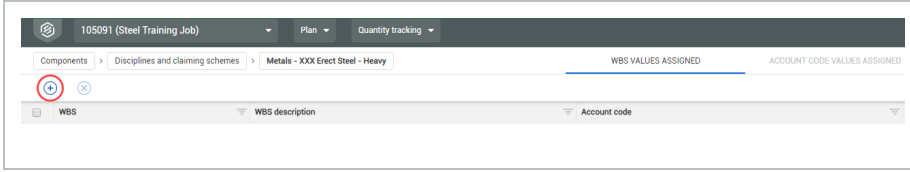

4. On the resulting slide out panel on the right, search for the WBS you created while learning InEight Control.

If you can't find your WBS use **WBS 1004** to follow along with the Steel Training Job scenario.

5. When the WBS appears, click on the **Add** icon on the left.

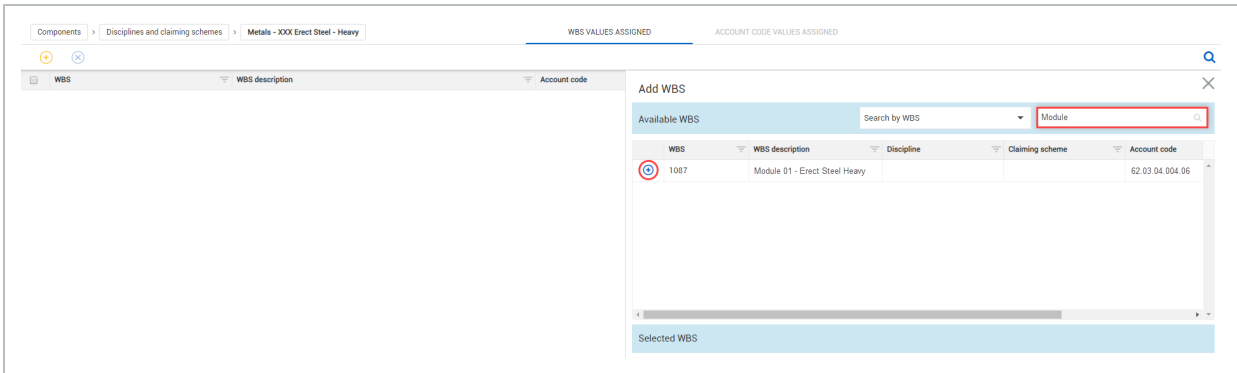

Multiple WBS items can be assigned to a single claiming scheme. Make sure to select the Module # of the computer you are using.

- You should see your WBS has moved to the **Selected WBS field** below
6. Click **Done** on the bottom right of the screen.

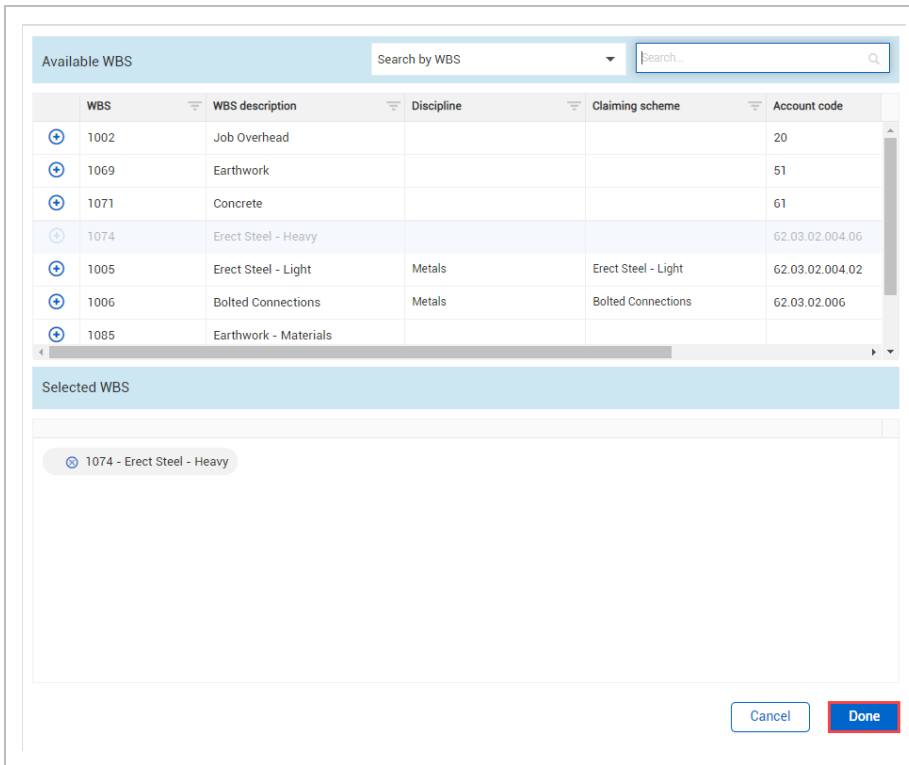

Follow the same process for assigning an Account Code to a claiming scheme.

After you have assigned an account code to a claiming scheme, select the **check box** next to the claiming scheme. Then, select the **Map Account Code to WBS** icon in the top right of the Disciplines and Commodities tab to automatically map WBS to the associated account code. There, you can select multiple claiming schemes to map all of them at the same time.

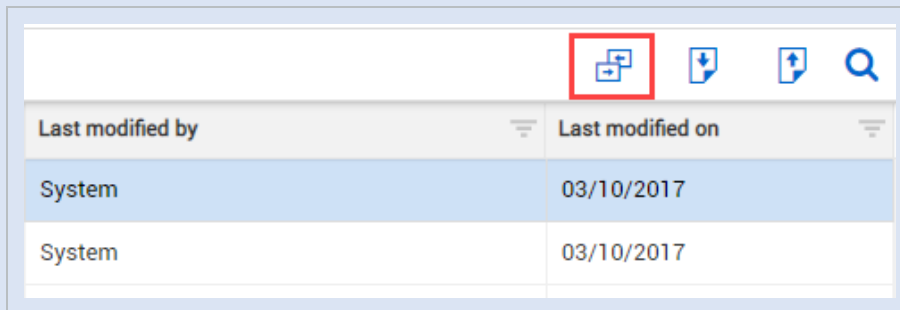

3.3.2 Edit Claiming Schemes

In this step by step you will add a quality verification step to the claiming scheme you created previously.

The following step by step walks you through how to edit a claiming scheme.

Edit a Claiming Scheme

1. From the Quantity Tracking page, click the **Action menu** and then select **Manage claiming schemes** from the drop-down menu.

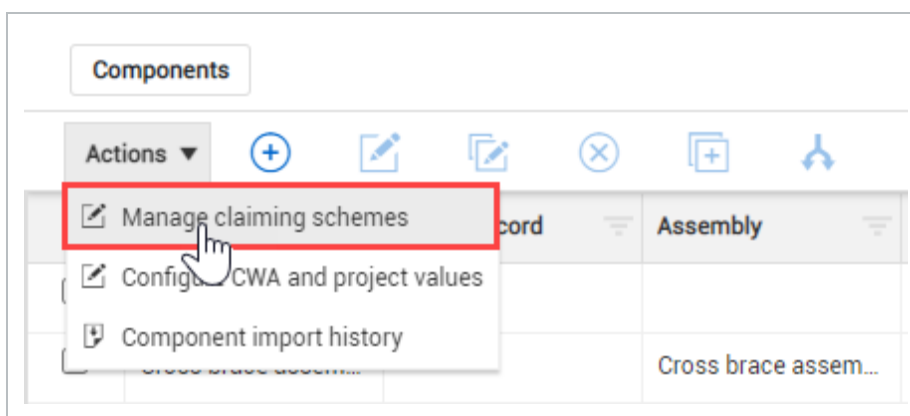

2. Click the **arrow** next to a discipline to expand its list of child-level claiming schemes.

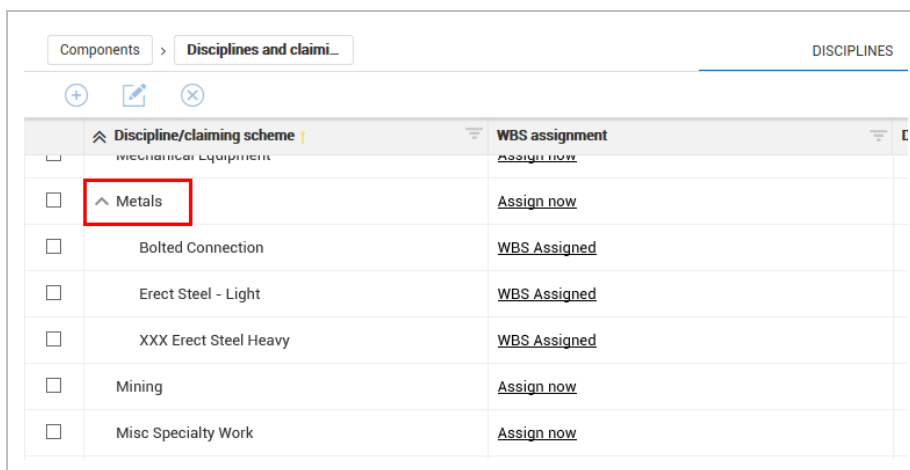

3. Select the **check box** to the left of the claiming scheme you created.

4. Click the **Edit** icon.

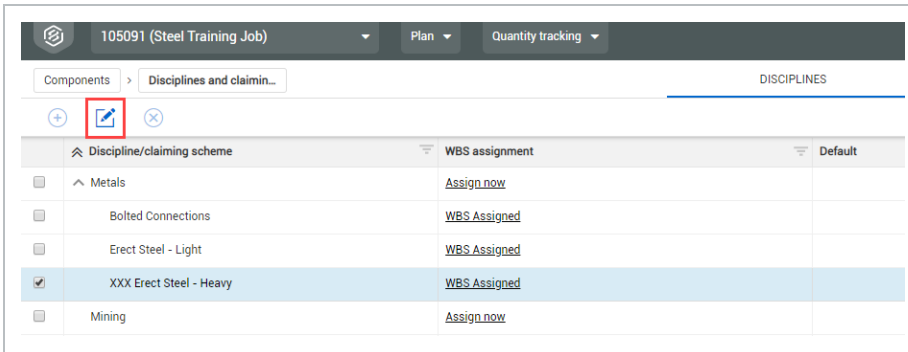

5. Click **Add step**.

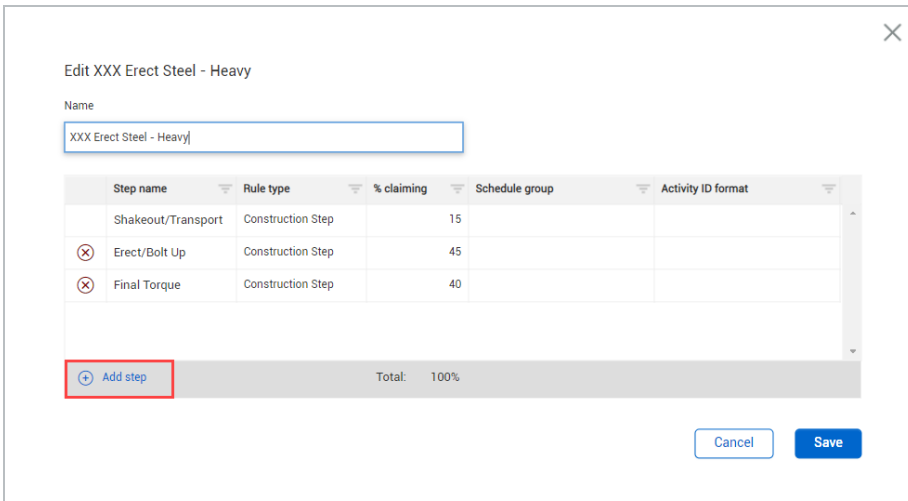

6. Lower the percentage for one of your existing steps.

Edit XXX Erect Steel Heavy

Name
XXX Erect Steel Heavy

Step name	Rule type	% claiming	Schedule group	Activity ID format
Shakeout / Transp...	Construction Step	15		
⊗ Erect / Bolt Up	Construction Step	45		
⊗ Final Torque	Construction Step	30		
⊗ Step 4		0		

+ Add step Total: 100%

Cancel Save

7. Add a fourth step. Name it, assign it a rule type, and give it a percentage so that all steps add up to 100%.

Edit XXX Erect Steel Heavy

Name
XXX Erect Steel Heavy

Step name	Rule type	% claiming	Schedule group	Activity ID format
Shakeout / Transp...	Construction Step	15		
⊗ Erect / Bolt Up	Construction Step	45		
⊗ Final Torque	Construction Step	30		
⊗ Quantity Verification	Quality Step	10		

+ Add step Total: 100%

Cancel Save

You cannot save a claiming scheme if your steps' percentages do not add up to 100%.

You cannot edit any claiming scheme that has a quantity claimed against it.

8. Click **Save**.

This page intentionally left blank.

CHAPTER 4 – COMPONENT MANAGEMENT

4.1 INEIGHT PLAN WORKFLOW - COMPONENT MANAGEMENT

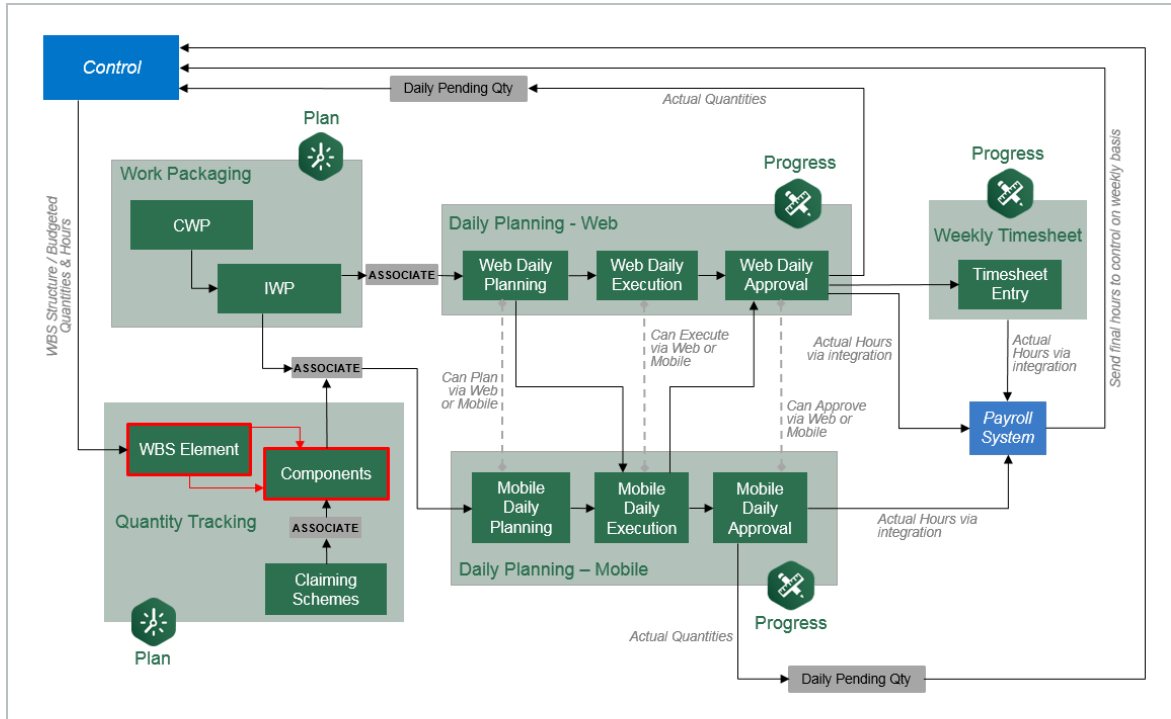

4.2 COMPONENT CREATION FROM SCRATCH

In this topic, you will create a new component from scratch in InEight Plan.

4.2.1 Create Components

In InEight Control, a direct cost item (WBS phase codes) has a quantity that is the sum of many components with smaller quantities which are created in InEight Plan. For example, a structural steel cost item measured in tons is made up of many pieces of steel, each with a specific weight (in tons). When claiming work complete, you could calculate the weight of each piece of steel installed and claim that much at the WBS level.

- *If you did this, how would you know what work is complete and what specific work is remaining?*
- *What have you already claimed and what have you not?*

- *What if a Foreman doesn't have the time to weigh each piece of steel before installing, or what if he weighs incorrectly?*

Components allow you to break down the WBS quantity into smaller, more manageable sub items for claiming. When you claim components, you can easily see what specific items have been completed and what is remaining. You do not have to guess at what has already been claimed to date. Foremen do not need to do any calculating in the field; they simply report the components they completed. Components already have an assigned quantity based on takeoff calculations.

- *Can you think of how components would help claiming of other disciplines like Pipe, Electrical, or Concrete?*
- *How are these disciplines measured vs how is the work performed?*

Components aim to bridge that gap.

4.2.2 Types of Components

There are several types of components in the Quantity Tracking module:

- Activity
- Material
- Assembly
- Contract

You can create activity, material, and assembly components directly in Plan. Contract components can only be created indirectly from InEight Contract.

These different types let you claim procurement activities and construction activities separately. To do this, material cost and labor cost must be broken out in separate WBS codes. If that is the case, you can add the same steel components as activity components and material components as pictured below:

	Name ↑	Parent record	Assembly	Type	Discipline / Commod...	Claiming sc...	WBS	Description
<input type="checkbox"/>	Module 01 - A23: C...	Cross brace assem...	Cross brace assem...	Material	Steel	Steel	1087	
<input type="checkbox"/>	Module 01 - A23: C...	Module 01 - A23: C...	Cross brace assem...	Activity	Metals	Erect Steel - L...	1005	Module 1 - A2...

When you create components for both the material and activity, you can then earn hours based on a unit rate for the activity, and earn dollars based on material unit cost for the material and assign them to two separate WBS codes.

Component types are shown with different color schemes:

- Activity: Blue
- Material: Gray
- Contract: Metallic purple
- Assembly: Forest green

4.2.2.1 Assembly Components

You can combine activity and material components into assembly components. An assembly allows claiming to roll up into one parent record.







For example, if you are building a wall using 2x4s, you might have the following components:

- Material of 2x4s
- Activity of cutting 2x4s to lengths from rough cut
- Activity of labor to assemble 2x4s into wall

If you create a new assembly component to build a 2x4 wall, you can set the parent record of the material and labor activities to be the assembly. If you set the parent record of the cutting activity to be the material, the cutting activity also becomes part of the assembly. Using assembly components and parent records lets you create hierarchies of components so that claiming rolls up into one record. The new Assembly column shows which assembly each component belongs to.

When you edit an assembly or material component, you can use the Related Components tab in the slide-out panel to associate existing components. Only associated components lower in the hierarchy are shown.

You can only add associations from the Related Components tab. To remove an association, you must edit the Parent record field of the associated component.

Components				
Actions      				
	Name	Parent record	Assembly	Type
<input type="checkbox"/>	Assembly of build 2x4 wall		Assembly of build 2x4 wall	Assembly
<input type="checkbox"/>	Material of 2x4's	Assembly of build 2x4 wall	Assembly of build 2x4 wall	Material
<input type="checkbox"/>	Activity for labor to assembly 2x4's into wall	Assembly of build 2x4 wall	Assembly of build 2x4 wall	Activity
<input type="checkbox"/>	Activity to cut 2x4's to length from rough cut	Material of 2x4's	Assembly of build 2x4 wall	Activity

4.2.2.2 Contract Components

Contract components cannot be created directly in Plan. A Schedule of Values (SOV) item from Contract automatically becomes a contract component in Plan if the SOV is not set to hide in Plan and Progress.

In Quantity tracking, a contract component's basic details from Contract cannot be edited. You can associate a contract component to an assembly.

You can assign a contract component to a claiming scheme by adding a claiming scheme to the Contract discipline in Actions > **Manage claiming schemes**. You can then edit a contract component to change the claiming scheme. A contract component can only be in the Contract discipline. See [Claiming Scheme Creation](#) for more information on how to add a claiming scheme.

4.2.3 Methods of Creating Components

There are four methods for creating activity, material, and assembly components:

Component Creation	
From Scratch	Create each component manually using the new component slide out panel.
Import Template	Import multiple components into InEight Plan simultaneously.
Copy	Create one new component from an existing component.
Split	Create multiple new components from an existing component.

4.2.4 Component Attributes

When creating components, a number of fields called attributes are available to be filled out. It is not necessary to fill out every single field, but the more information input, the better. Attributes help make tracking components easier. In many cases, depending on the size of the job, you may have hundreds of thousands of components. In such a case, it can be difficult at times to distinguish the differences between components if only a few attributes are filled out.

4.2.4.3 Validated Fields

You will rely heavily on certain component attributes for reporting purposes. For these attributes, it is important that data integrity is maintained.

For example, the area and system fields are commonly used for reporting. For these fields, it is important that the area and system entered are always spelled and formatted exactly the same way every time. Imagine a scenario where the data entered for the area field is spelled and formatted five different ways by five different users. In this case, when a report is run for areas, the report will only identify the data that is spelled and formatted one of the five ways. All data for the other four will be left out and your report will be missing crucial information.

To solve this problem, validated fields are used. Validated fields are simply a pre-defined list of values that populate into a drop-down menu. Instead of making these fields free text fields, a drop-down list is utilized. This drop-down list is maintained in the Configure CWA and project values page. You access the Configure CWA and project values page from the Actions menu on the Components page in Quantity tracking.

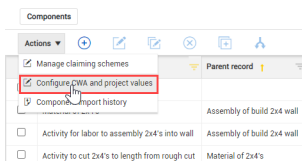

4.2.4.4 Location

In the Location section of the Configure CWA and Project Values page, you can add a construction areas, construction segments, and commodities as data validated tag values to assign to components. Examples of construction areas are North and South. An example of a construction segment is Phase 1. Examples of commodities are rebar and steel. These can then be used to map your components for reporting.

Depending on how your project is set up, if you assign a component to a work area in Work packaging, the component's location is updated to match the work area and cannot be edited in Quantity tracking. The setting that controls this behavior is called Automatically inherit CWA to component from assigned work package.

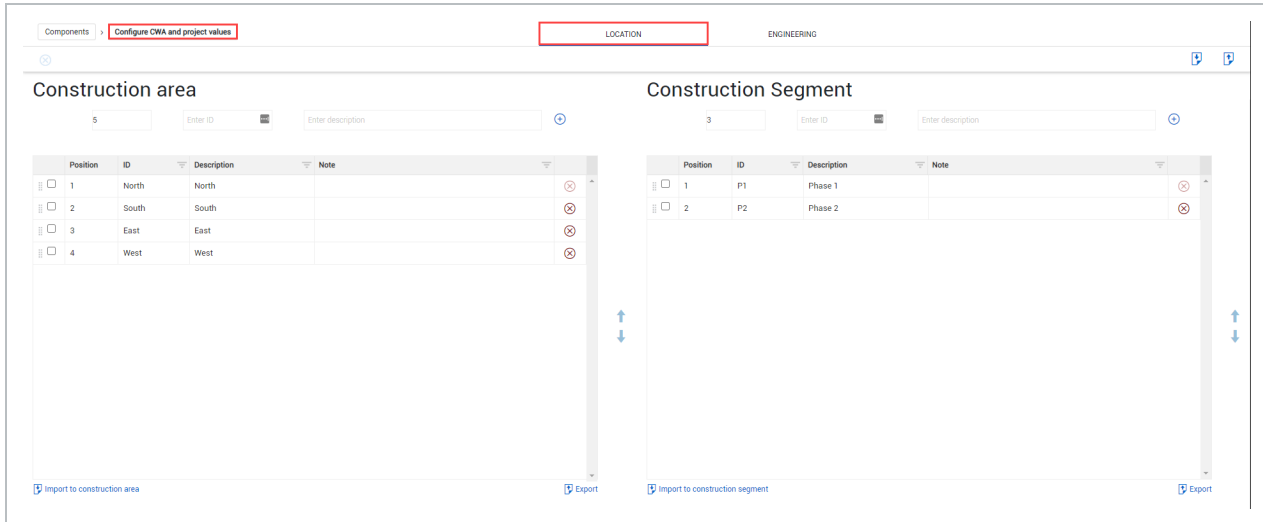

4.2.4.5 Engineering

In the Engineering section of the Configure CWA and Project Values page, you can associate turnover packages and systems of work such as fire, water, or sprinkler to a component. You can further define subsystems for a component. Depending on your permissions, you might not be able to edit component attributes, which are typically maintained by an administrator. If you need the drop-down list for a validated field update and do not have access, contact your system administrator.

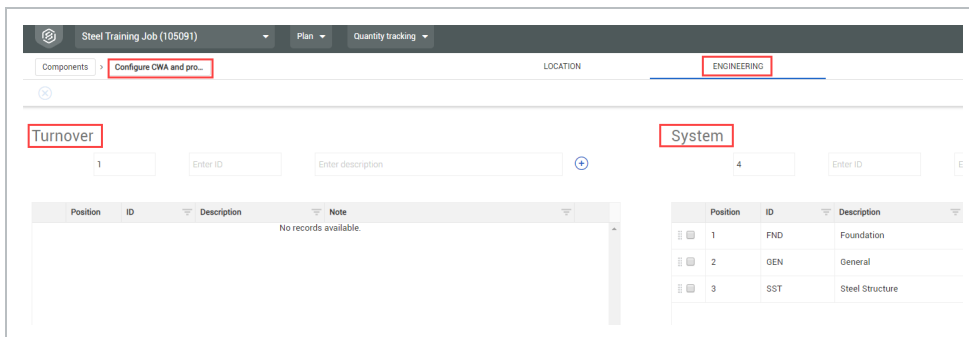

The Engineering section in the Edit activity component > **Component Details** tab also lets you link InEight Design data to a plan component. You can enter or update the turnover complete date, test package, complete date, and owner code.

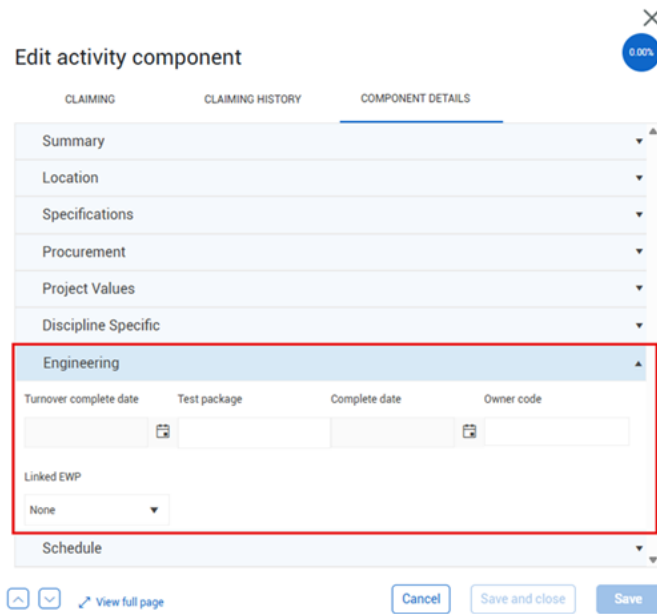

4.2.4.6 Using Component Attributes

On the Quantity tracking Components page, you can add the component attribute columns to your view. Clicking into a field under one of the component attribute columns provides the drop-down values for the attribute as defined previously on the Configure CWA and Project values page.

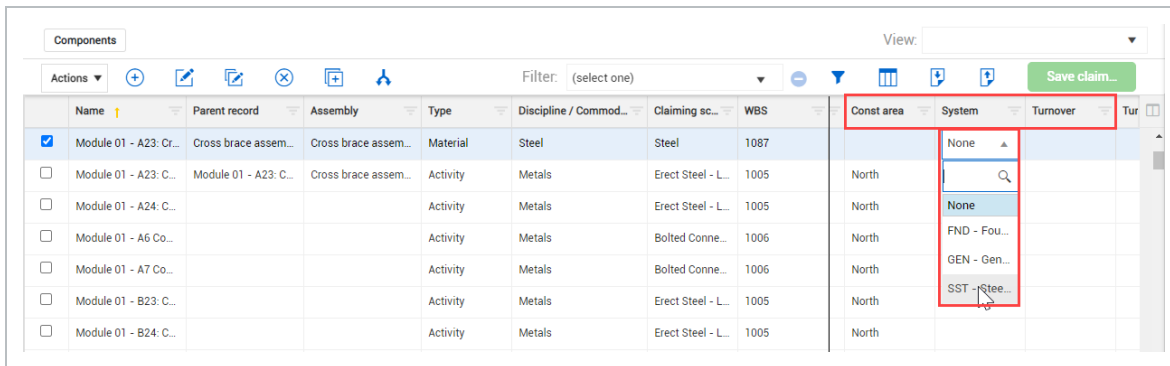

4.2.4.7 Split Contract Components

You can split a contract component into new smaller components. In Quantity tracking you can select a single component, and then click the Split component icon. The Split component dialog box opens. You

can split the original component to up to 50 new components. You can apply quantity to the new components. The original component (line 1 in the split component window) will have its quantity reduced.

The original component cannot be set to a value less than zero. If all the quantities are associated to the split components, then the lowest value the original component can be set to is zero.

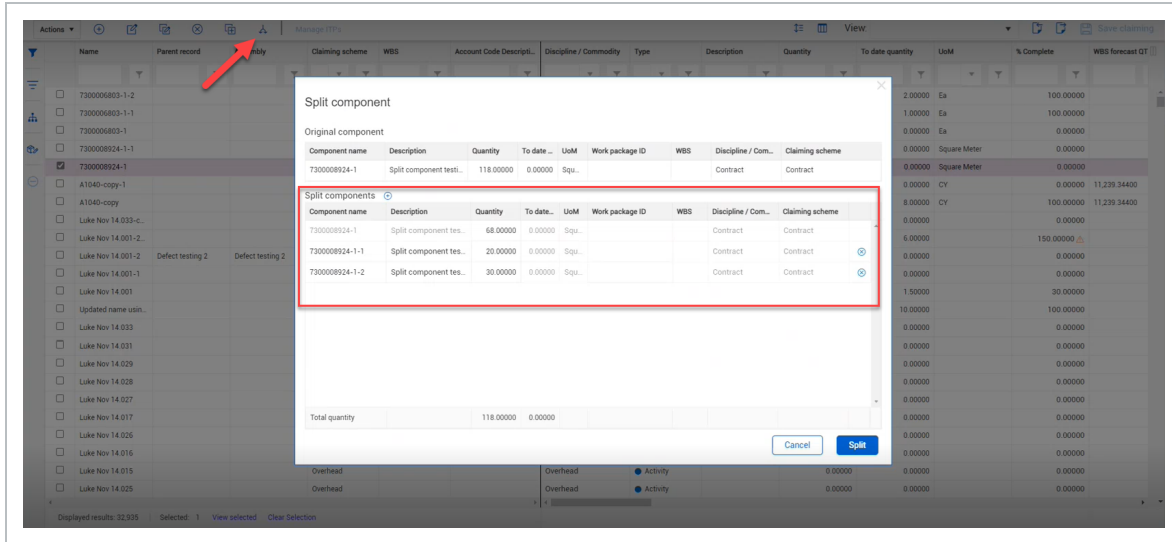

4.2.4.8 Validated lists in Field attributes

The Field attributes drop-down list is found under the Discipline Specific section of the Edit activity components dialog box.

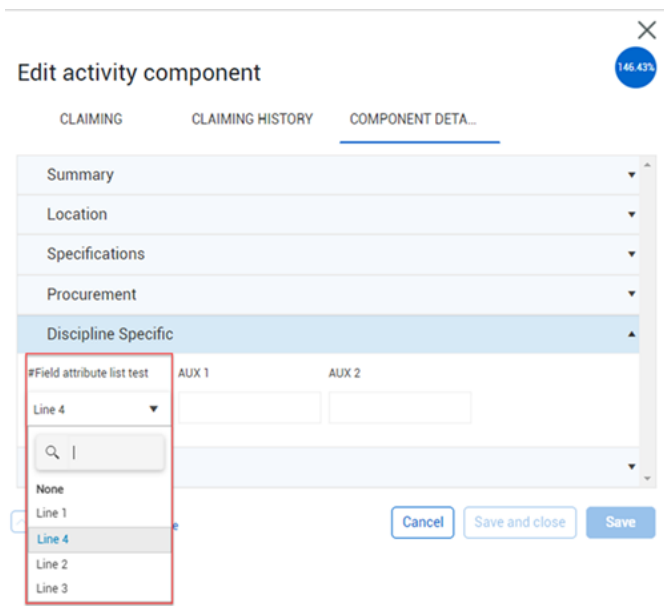

To create the validated lists, go to Platform> Master data libraries> **Attributes** and then click the **Add attribute** icon. The Add attribute dialog box opens, enter the attribute information. In the Type field, select **Validated list**. After you save the attribute, it shows on the Field attributes page.

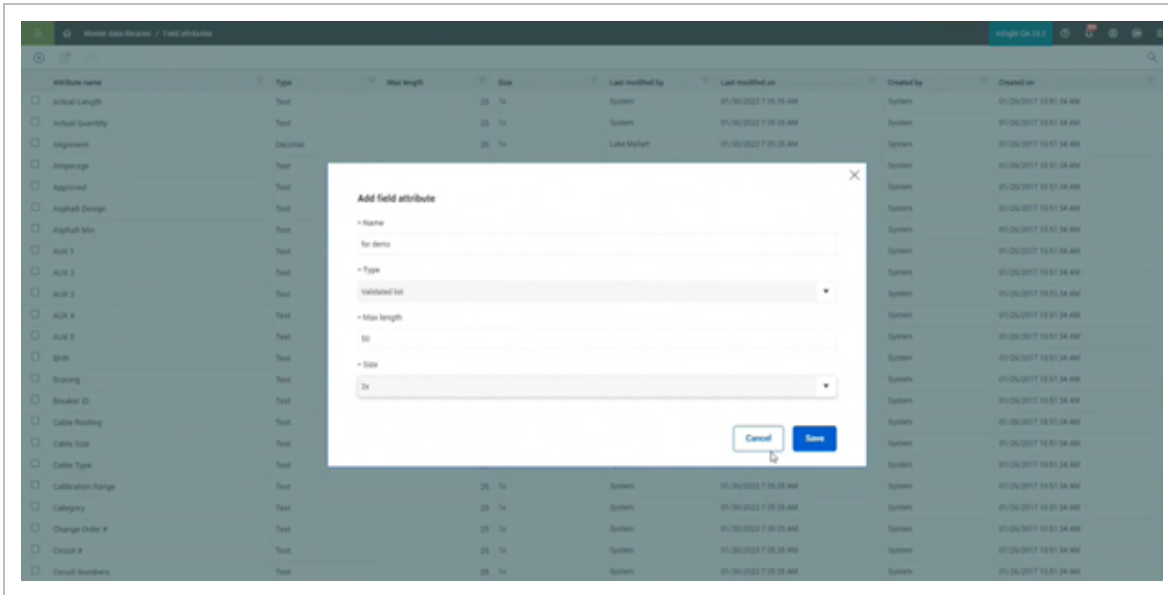

4.2.4.9 Schedule Components

The Schedule section in Edit activity component > **Component Details** tab lets you manage schedule details directly from an activity component. You can enter or update the Activity ID, Activity name, Planned start date, and Planned end date of a schedule. You can enter free-form text or search existing data. If an existing Activity ID is selected, all other fields are populated with any data from InEight XER imports. The Do not schedule check box integrates information from InEight Design.

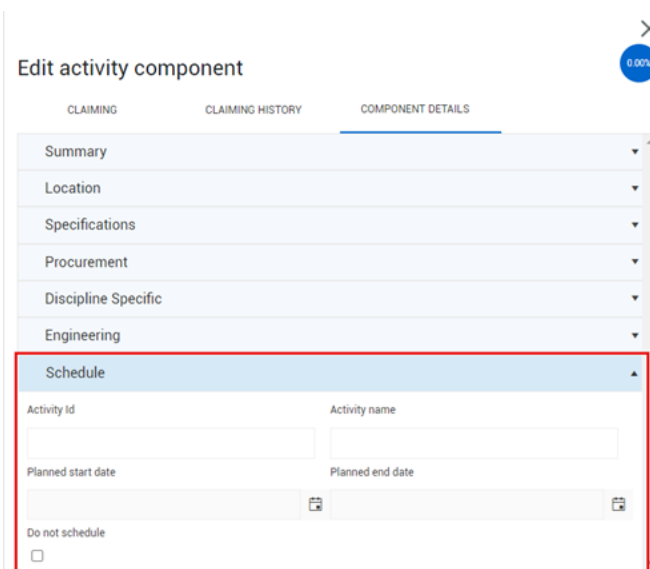

4.2.4.10 Project Values

Assigned project value types are created in the master data library, they can be linked to a project, which then lists the project values in quantity tracking. Go to Quantity Tracking > Column chooser to add the project values to your grid view.

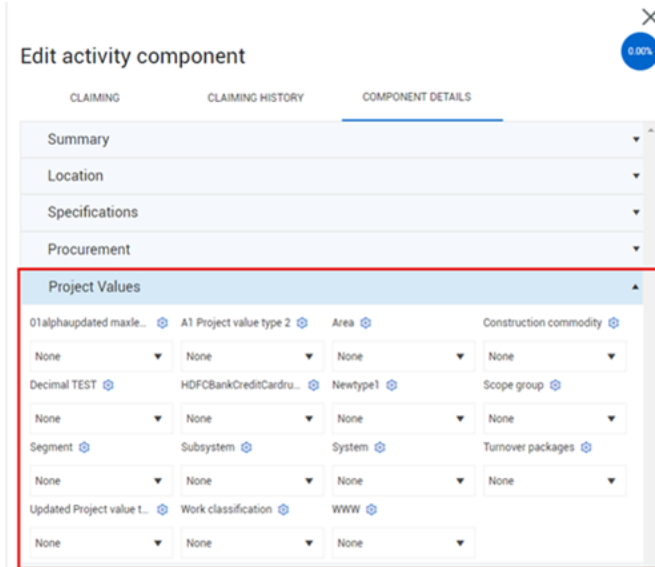

Overview - New Component Slide Out Panel

Title		Description
1	Summary Menu	Contains general high-level component information such as Name, WBS, Quantity, Unit of Measure, and Discipline.
2	Location Menu	Contains exact location information of the component such as Building, Elevation, Construction area, and System.
3	Specifications Menu	Contains information regarding exact specification for the component such as: Size, Weight, Thickness, Material code, and External link.
4	Procurement Menu	Contains information regarding the procurement of the component such as Supplier, PO #, and Shop/Field. This section also shows related contract information for contract components..
5	Discipline Specific Menu	Contains information that is specific to the discipline selected in the summary menu. This is different for every discipline.
6	Engineering	Contains information regarding the engineering of the component such as Turnover, Test Package, and Owner Code.

Overview - New Component Slide Out Panel (continued)

Title		Description
7	Claiming Scheme Menu	Shows the claiming scheme selected in the summary menu.
8	Claiming History	Shows a log of what has been claimed to date for this component and by whom.
9	View Full Page Link	Opens the slide-out panel into a separate window and expands all menus. Allows for scrolling through the menus instead of opening accordions individually.
10	% Complete Field	Shows overall percent complete of the component.

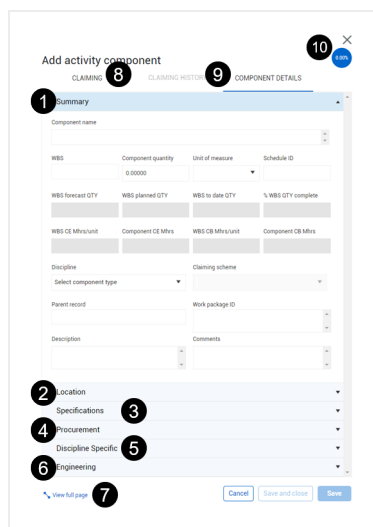

4.2.5 Component Creation

The following step by step walks you through how to create a component from scratch.

Create a Component from Scratch

1. From an open project, go to the **Quantity Tracking** module.
2. To create a component, select the **Add** icon on the left toolbar.



3. Select **Activity**.

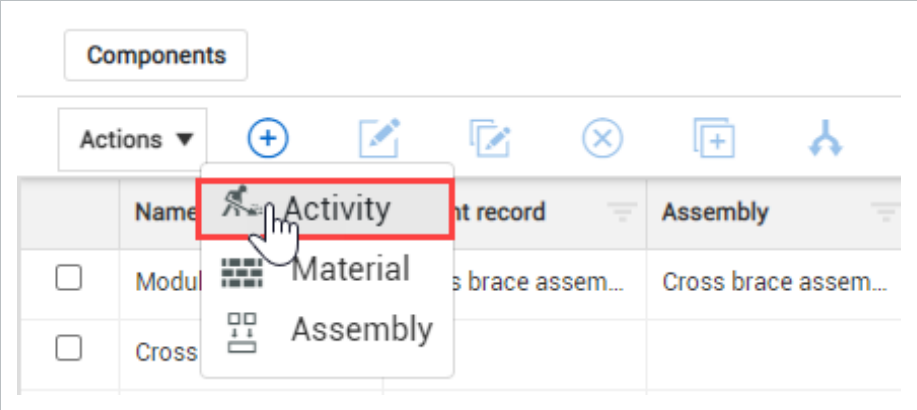

- This opens the new activity component slide out-panel. By default, the summary accordion menu should be expanded

4. In the Summary menu, enter your component details.

Add activity component

CLAIMING CLAIMING HISTORY COMPONENT DETAILS

Summary

Component name

WBS Component quantity Unit of measure Schedule ID

WBS forecast QTY WBS planned QTY WBS to date QTY % WBS QTY complete

Discipline Claiming scheme Work package ID

Parent material

Description Comments

Location

Specifications

Procurement

Depending on what project setting you have set up, when you assign your WBS, the Unit of Measure, Discipline, and Discipline/Claiming Scheme fields might be automatically populated and locked for editing.

You can associate material components and assembly components to activity components by adding materials or assemblies to the Parent record field. To associate materials, check that you have the setting Associate Claiming to Material Components turned on in your Project Settings > **Plan Quantity Tracking**.

5. Open the Location menu by clicking on the **Location** title header.
6. In the Location menu, enter the location and commodity information.
7. Open the **Discipline specific** menu and enter your grade and coating information.

The screenshot shows the 'Add activity component' dialog box with the 'Component Details' tab selected. The 'Discipline Specific' section is expanded, showing a grid of input fields. The 'Coating' field is set to 'GALV' and the 'Grade' field is set to 'A992', both highlighted with red boxes. At the bottom of the dialog are buttons for 'View full page', 'Cancel', 'Save and close', and 'Save'.

8. After you have completed filling out your information, click **Save**.

The following Step by Step walks you through how to create a component by copying an existing component.

Copy an Existing Component

1. Select a component.

The Copy function only works when you select a single component.

2. Click the **Copy** icon in the upper-left of the page.

The Copy component dialog box opens

3. Enter a name for the new component.

The default name adds -copy to the end of the original component's name

4. Click **Copy**.

The following Step by Step walks you through how to create multiple components by splitting an existing component.

Split an Existing Component

1. Select a component.

The Split function only works when you select a single component.

2. Click the **Split** icon in the upper-left of the page.

The Split component dialog box opens

3. Click the **Add** icon next to Split components to increase the number of new components to split the original into.

To remove a split component, click the **Remove** icon next to the component.

4. Enter names for the split components.

The default names add -n to the end of the original component's name, where n is an increasing number starting at 1

5. Change the Quantity for each of the split components.
6. Click **Split**.

The following Step by Step walks you through how to edit multiple components at the same time.

Bulk Edit Components

1. Select multiple components.

You can edit a maximum of 50 components at the same time.

2. Click the **Bulk edit** icon in the upper-left of the page.
 - The Bulk edit dialog box shows
3. In the dialog box, select a column and enter a new value for the column.
4. Add or remove additional columns as necessary, and then click **Save**.

You can edit a maximum of five columns at the same time.

The Bulk delete components option in the Actions menu lets you delete up to 500 components at a time. The components must have zero claimed quantity to be deleted. Components with installed quantity are never deleted, so only the first 500 zero-quantity components can be deleted. To help target specific components, bulk delete will work when filters are applied and only values with the selected filters will be deleted.

The following Step by Step walks you through how to delete components with zero claimed quantity in bulk.

4.2 Step by Step 1 – Bulk Delete Components

1. Open the **Actions** drop-down menu, and then select **Bulk Delete Components**.

A warning dialog box opens.
2. Select the confirmation check box.
3. Click **Delete**.

4.3 COMPONENT CREATION FROM IMPORT

In this topic, you will learn how to upload multiple components at once via the Import Template.

Scenario

Imagine you are the structural steel field engineer responsible for tracking all steel erection for your module. You receive a bill of materials from your steel fabricator that matches the erection drawings. The bill of materials has all the information you need to input for components - piecemarks, weight, grade, coating, etc. You need to add all the piecemarks as components, so you can track them as they are installed.

4.3.1 Import Template

You often receive lists of components from an outside source.

Can you think of other examples?

- *Electrical cable or termination schedules*
- *Pipe spool fabricator bill of materials*
- *Mechanical equipment list*
- *Take off sheets from estimators*

In these situations, it saves time to import multiple items at once. This can be done using the export and import feature in Plan.

The Import Template is a Microsoft Excel spreadsheet used to upload multiple components into Plan at once. The import template is generated first by setting up your view to show the columns of information you want to import, in addition to any required columns. Then you export the import template to Excel. You can export with or without data (by choosing Data Export), as well as, Excel equations. This means you can export just the column headers or all the information in the cells below as well. After export, you can fill in your information in the spreadsheet, save it, and import it. You have the option to import only new items or overwrite information on existing items (based on unique component IDs).

Component IDs are distinct from component names. You can have components with the same name, but they must have unique IDs. To change a component name, you must first know the component ID. This ID is used as the key reference point for all components. To find the component ID, from Quantity tracking in standard grid view, click the **Export** icon, and then select **Data export**. The Microsoft Excel file shows the component IDs in column A.

After import, Plan checks the file for any errors. Errors might include:

- Validated fields that don't exist
- WBS codes that are not available
- Non-unique component IDs

A report is generated to help you find and correct any errors before continuing the import.

The following step by step walks you through how to export the Import Template, populate it, and upload it back into Plan.

Component IDs must be unique within the same type of component (activity, material, or assembly). You cannot have two components of the same type with the exact same ID, but you can have an activity component with the same ID as a material component. If you want to duplicate an existing component (such as, the component created manually in the previous section), you must either delete it, or change the ID of either the existing or imported component.

Required columns are exported even if you hide them.

Create Components from Excel Import

1. From an open project, go to the **Quantity Tracking** module.

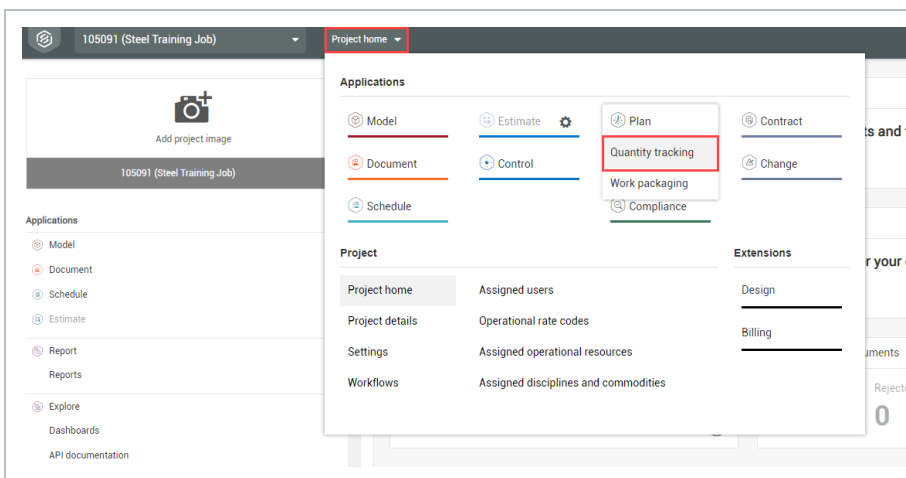

2. In Standard View, select the **Column Chooser** on the far right of the column header row.

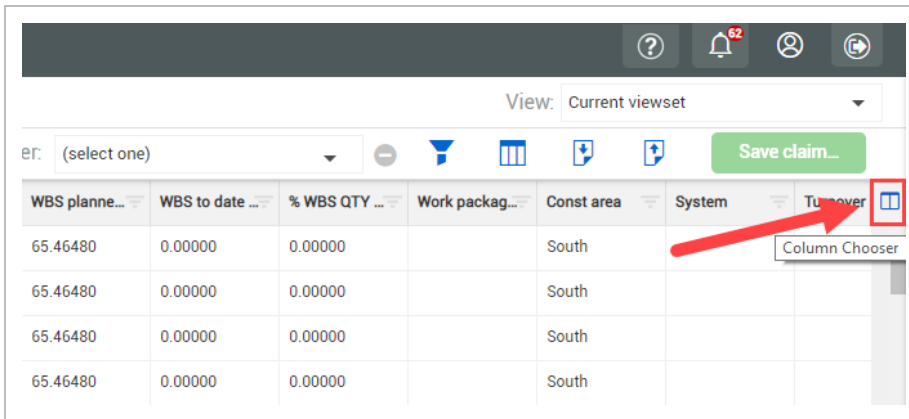

- From the Column Chooser dialog box, select columns from the **Available columns list**, and then use the **right arrow** to move them into the **Selected columns list**. Save your columns.

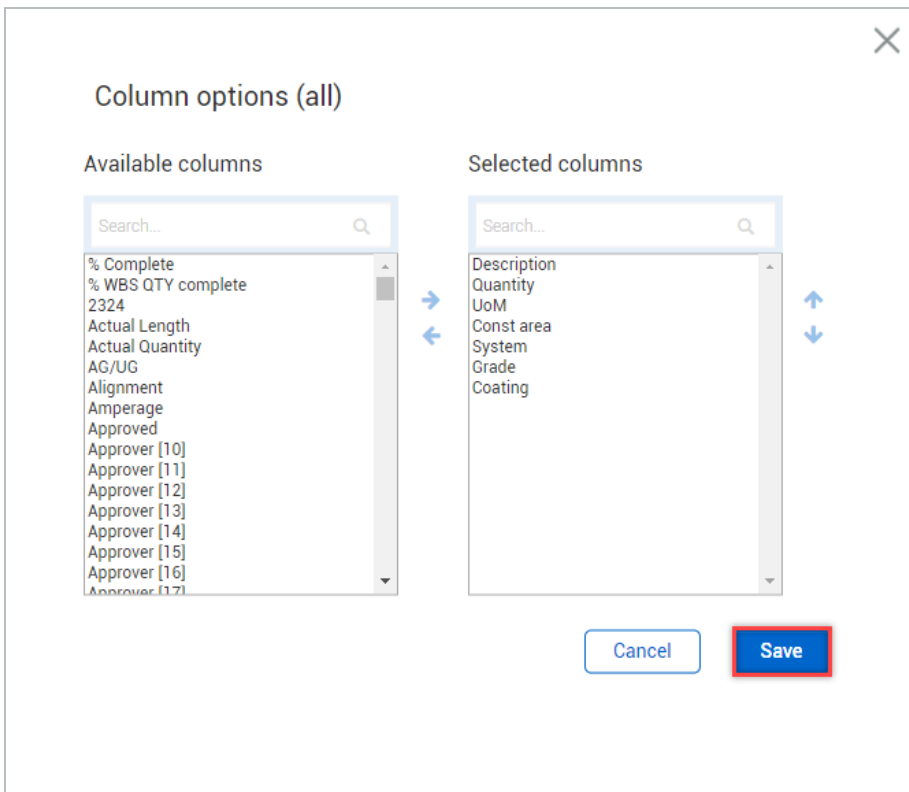

- Click the **Export** icon on the toolbar.

WBS to date ...	% WBS QTY ...	Work packag...	Const area	System	Turnover
0.15000	6.01685		South		
			South		
			South		

5. Select **Template**.

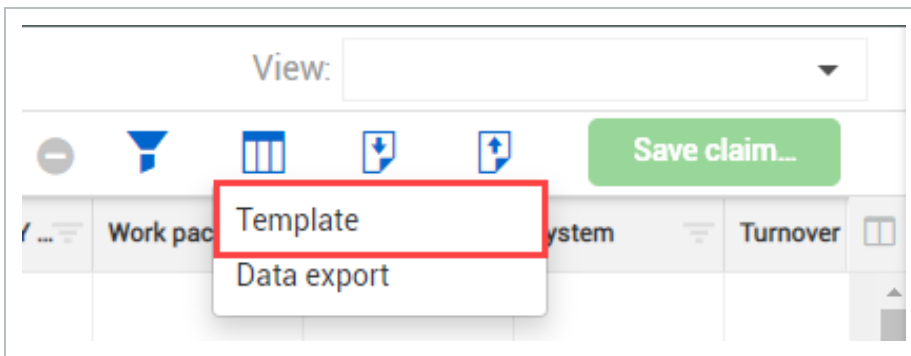

- A Microsoft Excel spreadsheet automatically opens or is shown at the bottom of your screen to download

6. Click the drop-down arrow for the file, and then select **Open**.

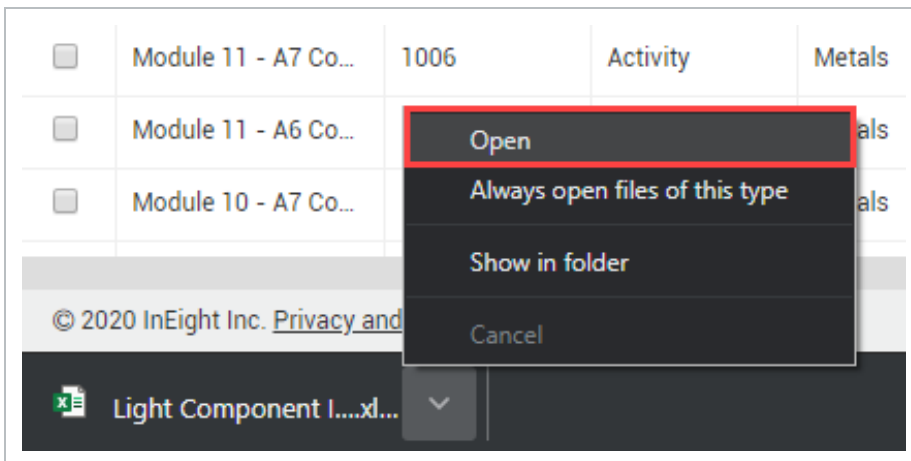

- The resulting spreadsheet is now your Import Template and contains all required columns and only the optional columns that were shown in Plan at the time of exporting

7. In the Name column, enter your component name.
8. Enter the component Name data.

9. **Save** the file to your desktop, so you can easily find it.

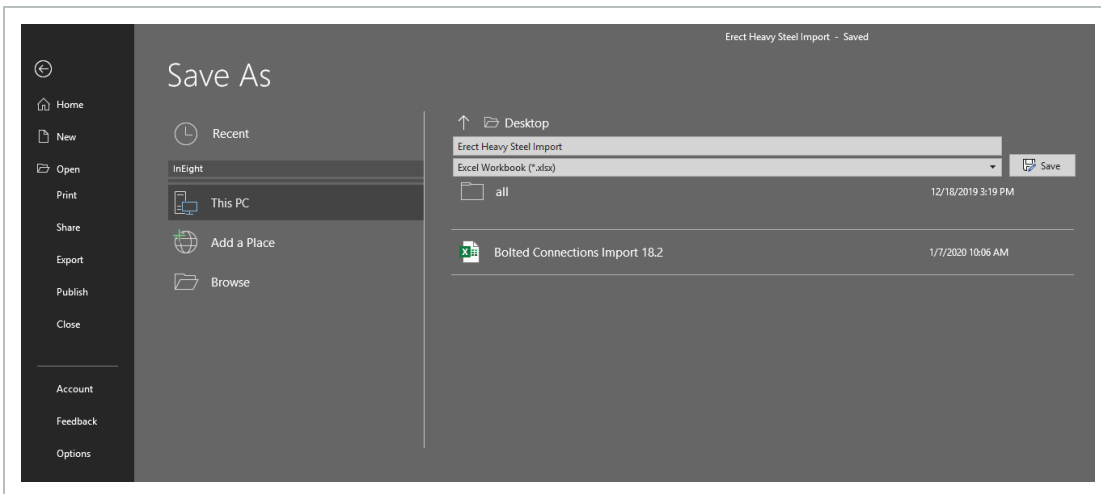

10. Return to Plan, and then click the **Import** button on the right toolbar.

WBS to date ...	% WBS QTY ...	Work packag...	Const area	System	Turnover
0.15000	6.01685		South		
			South		
			South		

- An Import data dialog box is shown

11. Select **Browse**.
12. From the resulting Open window, locate and select your file, and then select **Open**.
13. Select **Add new items only**.

Plan - Google Chrome

Import data from template

The data will be imported into Components

Drag and drop the file here or browse

[Browse...](#)

Add new items only
 Add new items and update existing
 Email me upon completion

[Cancel](#) [Import](#)

By selecting **Add new items only**, the system will flag an error if you've accidentally created a component with the same ID as a previously created component. If you select Add new items and update existing, instead of flagging an error for a component ID that already exists, the system overwrites the data for that component.

14. Click the **check box** for Email me upon completion.

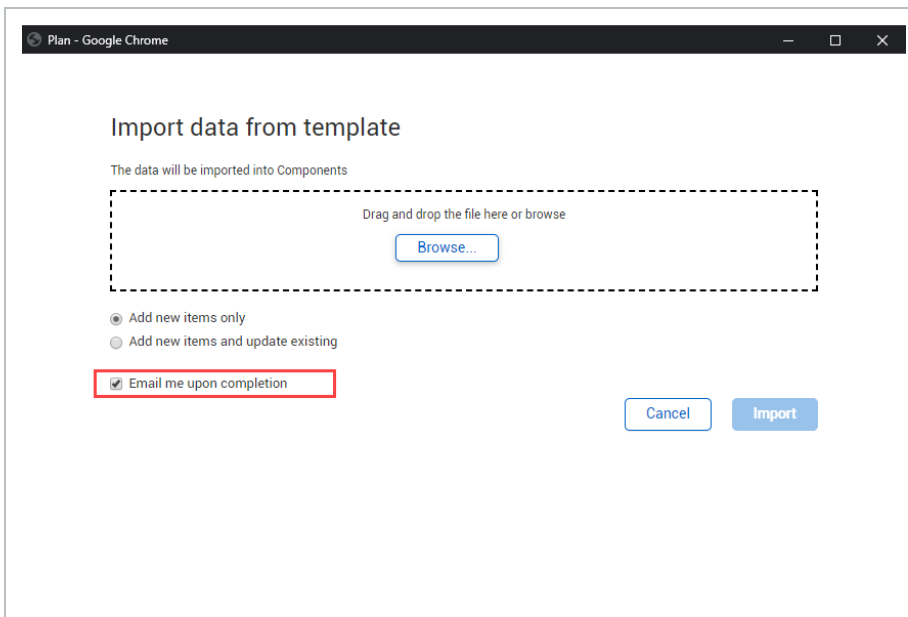

- This alerts you to the completion of the upload

15. Click **Import**.

- The import file is added to the import queue
- To see all your import files and their statuses, click **View file import queue**

You can continue working in the application while your imports are processed. A notification tells you if your file is imported successfully or not.

If you have an error, check that the ID of your component is not the same as an existing component.

16. Click **Close**.

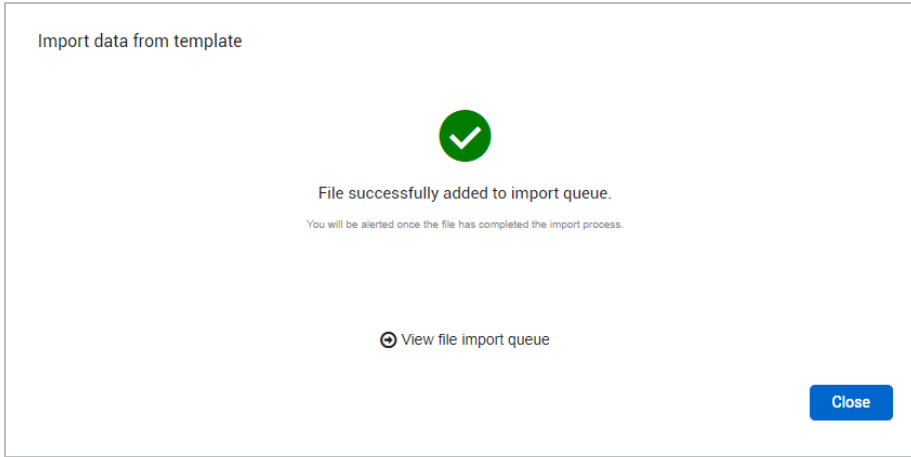

Scenario Recap

Now you can see how easy it is to upload multiple components. Picture a project with thousands of components from multiple sources that can be combined on an import template and easily loaded in quickly.

4.4 COMPONENT AUDIT LOG

This topic describes the Component audit log and how to use it.

4.4.1 Summary

The Component audit log lets you track changes made to components and in which systems the changes are made. The Audit log also lets you review Import and export history. To open the audit log from the Components list, select the Audit Log tab.

	Name	Parent record	Assembly	Type	Discipline / Commodity	Is default component	Description	Quantity
<input type="checkbox"/>	1084			Activity	WBS	True	Materials	1.0
<input type="checkbox"/>	1073			Activity	WBS	True	Structural Steel	1,246.0

The following table describes the different parts of the audit log.

Overview - Component Audit Log

Title		Description
1	Date range	Adjust the date range of data to be shown. You can choose from standard ranges or a custom range.
2	Export	Export a filtered view of the audit log.
3	Row density	Adjust how close together rows are shown.
4	Grid	Shows each change organized by columns, which can be filtered and sorted.

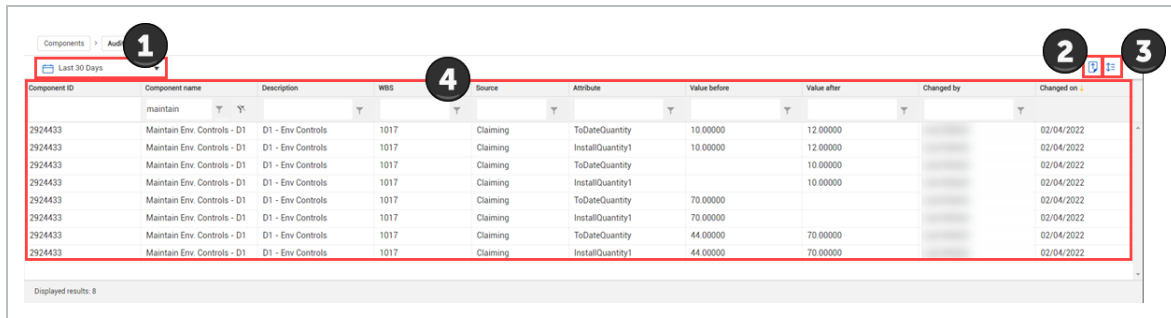

4.4.2 Considerations

- By default, the audit log shows the last 24 hours of changes made to components.
- Changes shown in the log depend on your permissions.

4.5 DEFAULT COMPONENTS

This topic describes default components and how they can be used in quantity tracking.

4.5.1 What are Default Components?

Default components are linked by WBS to cost items in InEight Control. Default components are automatically added to quantity tracking depending on organization and project settings for Plan and cost item properties in Control. Default components can also be used in InEight Progress.

Default components are useful to claim quantities against directly and as points of reference to create your own components that replace or supplement the defaults.

Many properties of a default component are brought in from the cost item in Control. For example, a default component's discipline or commodity and claiming scheme are set to WBS. These values are system generated and help you distinguish default components from user-created components.

A cost item from Control can be a default component depending on the following properties in Control:

- Allow as-built field - Values can be None, All, Quantities, or Costs. However, if this field is set to None or Costs, the default component cannot be claimed against in quantity tracking.
- As-built lock - If this check box is selected, the default component cannot be claimed against in quantity tracking.
- Hide in Plan/Progress - Do not select this check box.

If you add a new component with the same WBS, the default component is removed unless it has already been claimed against. If the default already has claiming, its remaining claiming value is reduced to the amount already claimed. Removed default components are still shown in reporting of inactive components and audit logs of claiming if the default component had claiming against it.

All default components are activity components.

4.5.2 Enable and Refresh Default Components

Default component settings are located in Settings > **Plan**, in the General section. You can turn default component creation on or off at both the organization and project levels. At the project level, you can refresh the list of default components, which is useful when you turn default component creation on after it has been off for some time.

4.5.2.1 Considerations for Enabling Default Components

Before you decide to enable, disable, or refresh default components, consider the following conditions.

If default component creation is:

- On at the organization level:
 - You cannot turn it off at the project level.
- On at any level:
 - If you refresh default components, quantity tracking's list of default components is updated. New default components might be created if their associated WBSs were added in InEight Control while default component creation was switched to *Off*.
 - You do not have to click Refresh every time a change is made to a cost item in Control. If the toggle is *On*, default components in quantity tracking show current data from Control.
- Off at the organization level:
 - You can adjust the setting at the project level as necessary.
- Off at the project level:
 - If you create components associated with WBSs, those components can still send claiming data to Control.
 - If you refresh default components after the setting was previously on, all default components without claiming are removed from quantity tracking.

The following step by step explains how to turn on default component creation for an organization, and then refresh a specific project's default components.

4.5 Step by Step 1 – Enable and Refresh Default Components

1. At the organization level, go to Settings > **Plan**.
2. In the General section, turn on **Enable default component creation**, and then click **Save**.
3. At the project level, go to Settings > **Plan**.
4. In the General section, click **Refresh**, and then click **Save**.

4.5.2.2 Delete default components

In Quantity Tracking, you can delete a default component. Select your component and then click the Delete icon to delete the default component.

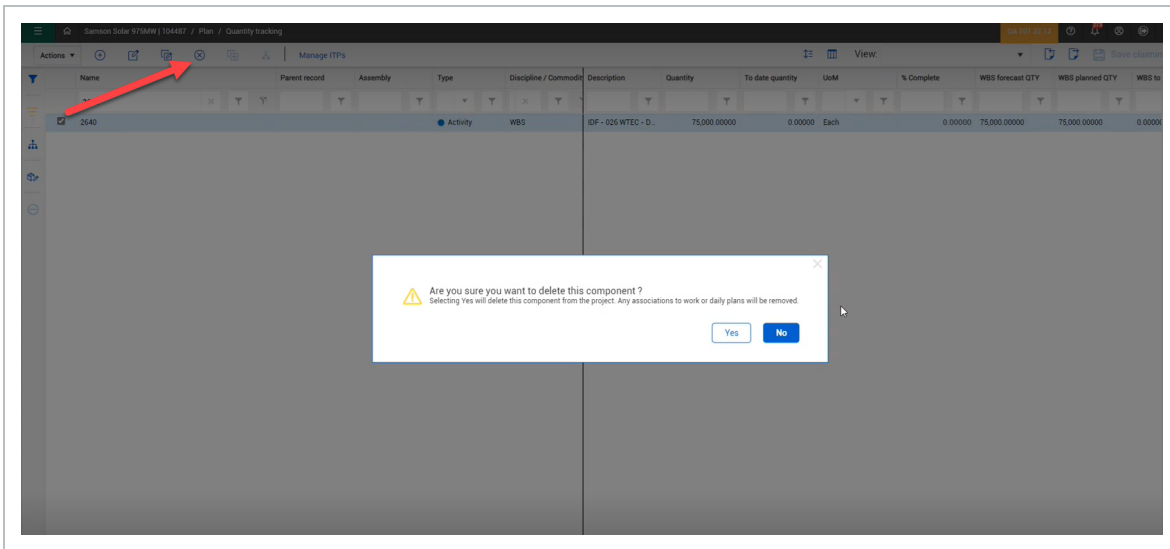

At the project level under the global options, you can restore the deleted default components by clicking **Refresh**. When you use this option, you will enable all default components.

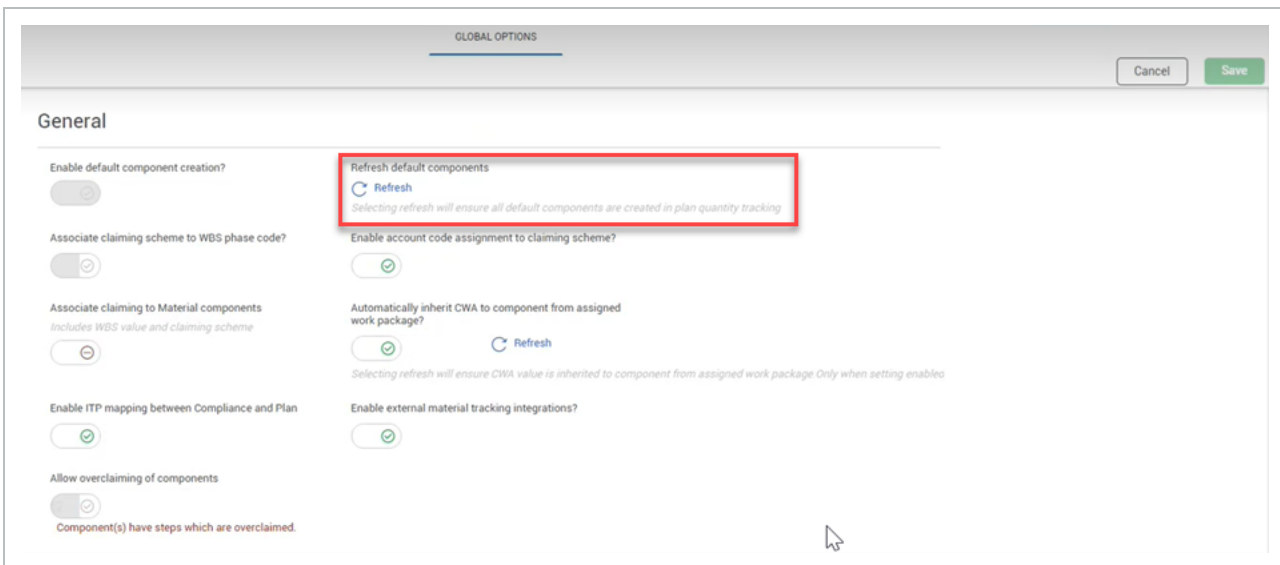

4.6 COMPONENT EXPORT HISTORY

The Export history log in Quantity Tracking lets you track the component export history.

To view the Export history log, go to Action menu > **Export history**.

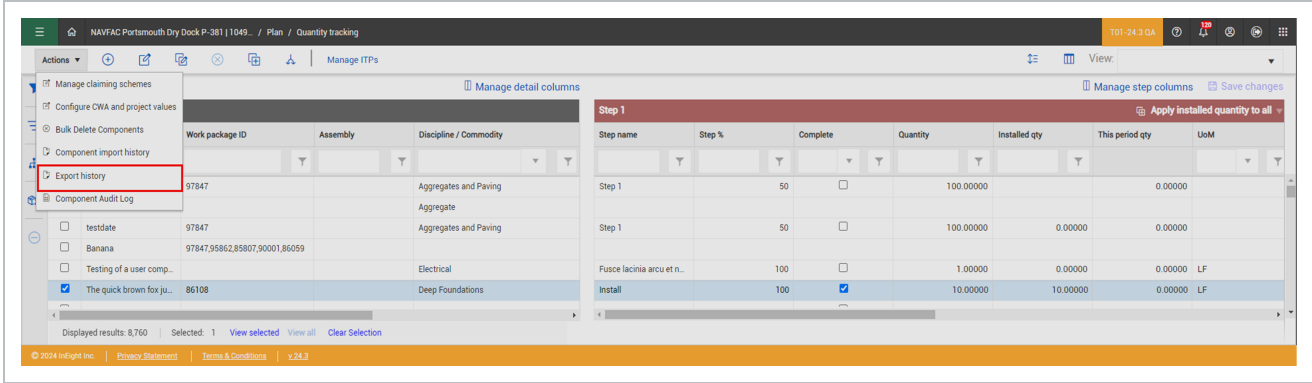

You can download previous component history logs and see who exported them.

To download, click the **Download** icon,

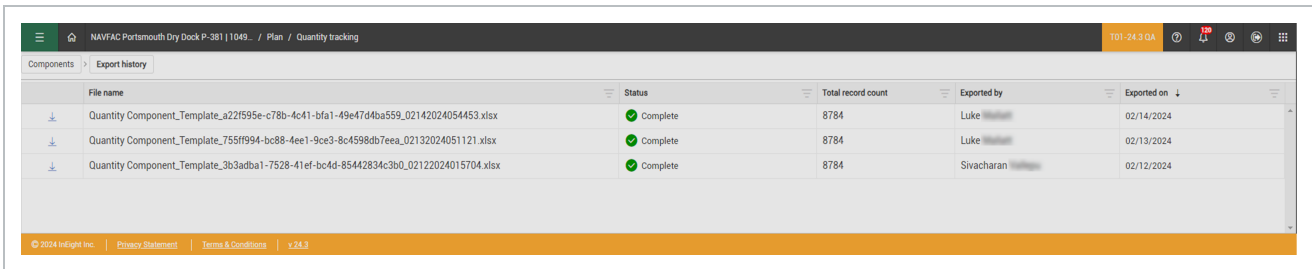

The export is a Microsoft Excel file with an unlimited component export count.

Longer record counts will result in a longer download time but, this is unlimited.

When exporting previous version history from yourself or other users, you can also undo changes.

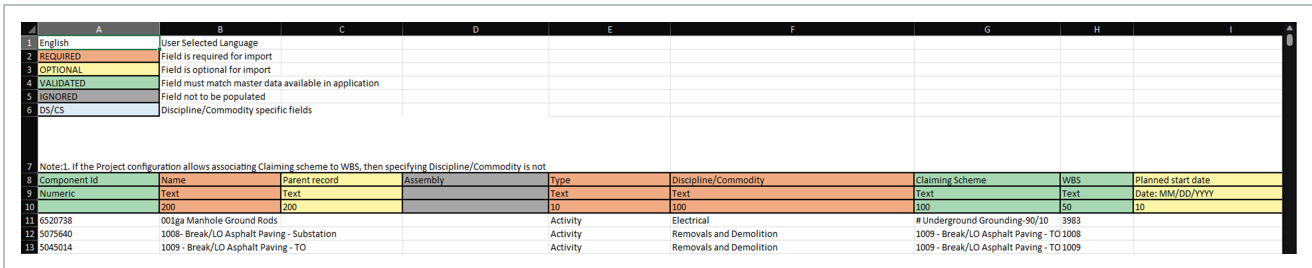

CHAPTER 5 – QUANTITY CLAIMING

5.1 INEIGHT PLAN WORKFLOW - QUANTITY CLAIMING

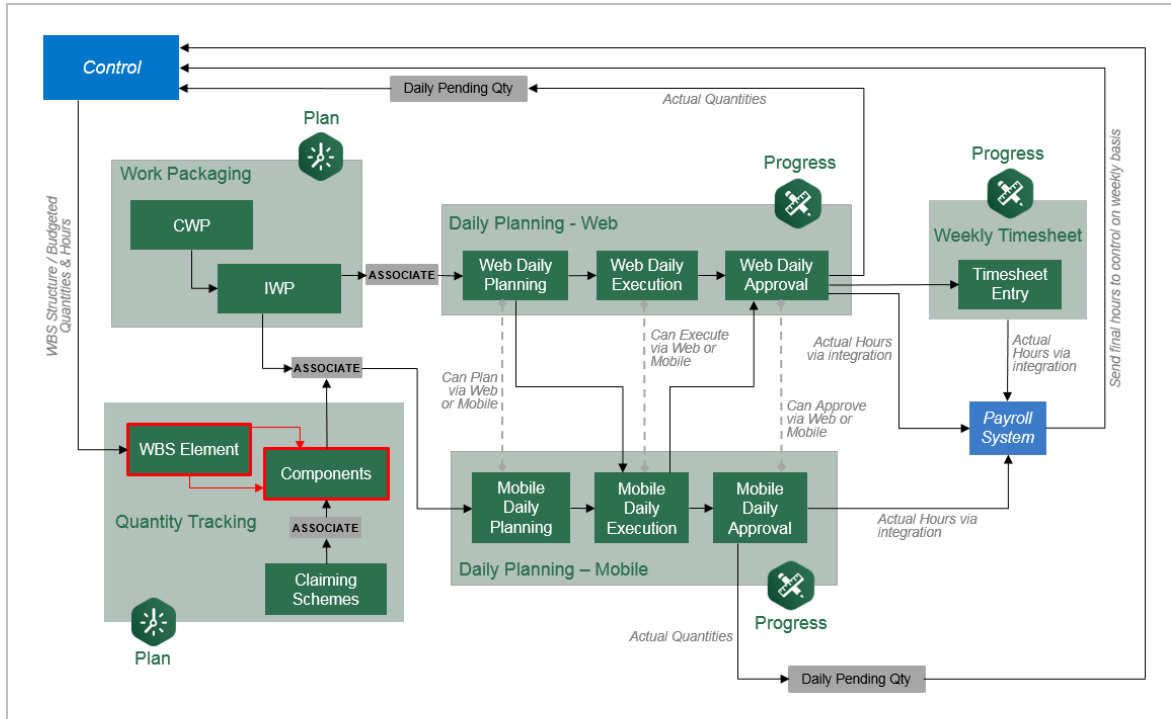

5.2 QUANTITY CLAIMING

This topic covers how to claim component quantities in the InEight Plan application.

5.2.1 Process for claiming quantities

Quantities can be claimed in Control, Plan or Progress. There are reasons to claim in each of the different modules, but this lesson will focus on claiming in Plan. Since labor and material are expended in the field, quantity for activities and materials can be claimed during the daily planning process of InEight Progress. This allows foremen to select (not calculate) the work they completed during the shift while filling out the time sheet at the end of the day, and it is reviewed by field engineers or superintendents before final quantities are approved. Sometimes, claiming in this fashion is not accurate and what was originally claimed needs to be revised. To manage claiming quantities without

having to create daily plans, it is important to understand how to use the Quantity Tracking module of Plan.

5.2.2 Why claim at a component level?

Claiming directly in the Quantity Tracking module of Plan is different than claiming in the Control module. In Quantity tracking, claims are made at the component level. This is more specific than claiming in Control at the WBS level. For example, suppose a WBS cost item has a quantity of 200 tons of steel. If 20 tons are erected so far, how would you know which specific pieces make up that 20 tons? How could you audit this claiming?

Direct labor and material codes should be claimed at the component level in the interest of transparency. Completed component quantities roll up into the WBS completed quantity. To enable quantities to be claimed in Plan, the cost item must have the Hide in Plan/Progress box unchecked within InEight Control and at least one component for that cost item must exist in Plan.

If two users concurrently are trying to claim quantities for the same component, the following error message will prompt them to refresh the page.

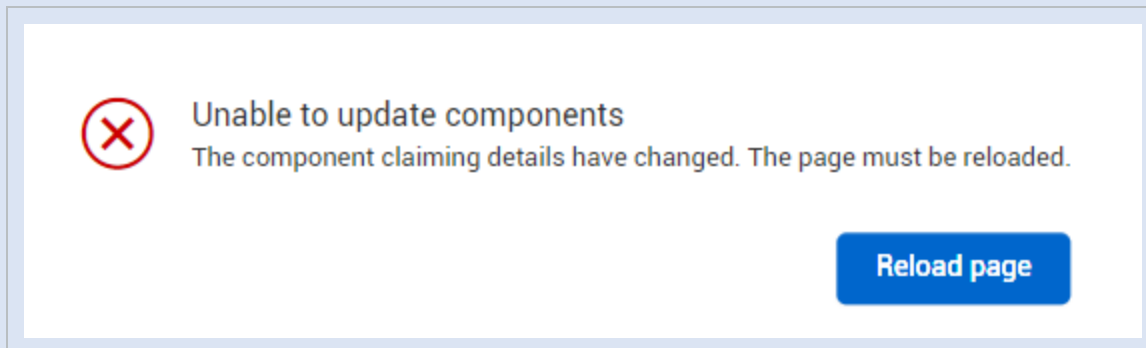

5.2.3 Claiming in the Standard Grid View

In the following Step by Step you will claim quantities in the Standard Grid view via the Edit component slide out panel.

Claiming is ideally done in the data block view, which lets you focus on only the information needed for claiming.

Quantity Claiming (Standard Grid View)

1. Navigate to the **Quantity Tracking page** and select the **View As button** to see your workspace in Standard Grid view.
2. Find and select the **check box** to the left of the component you previously created.
3. Click on the **Edit icon** to open the component editor slide out panel.

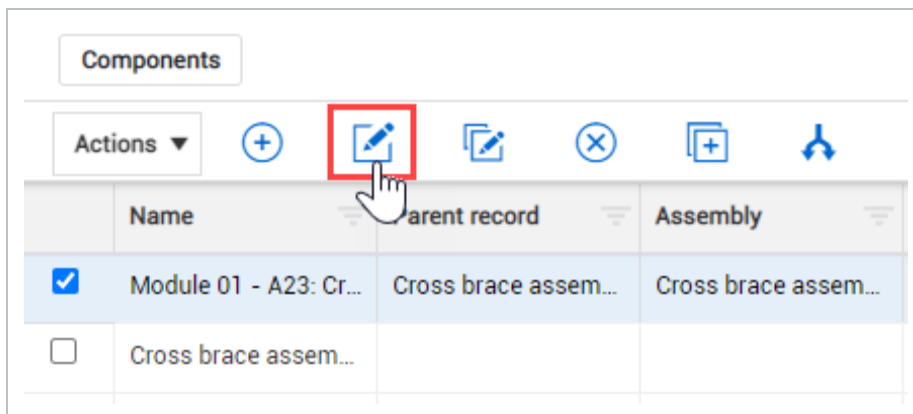

4. On the Claiming tab, check the box in the **Complete** column for step one.
5. Enter an Executor and Approver.

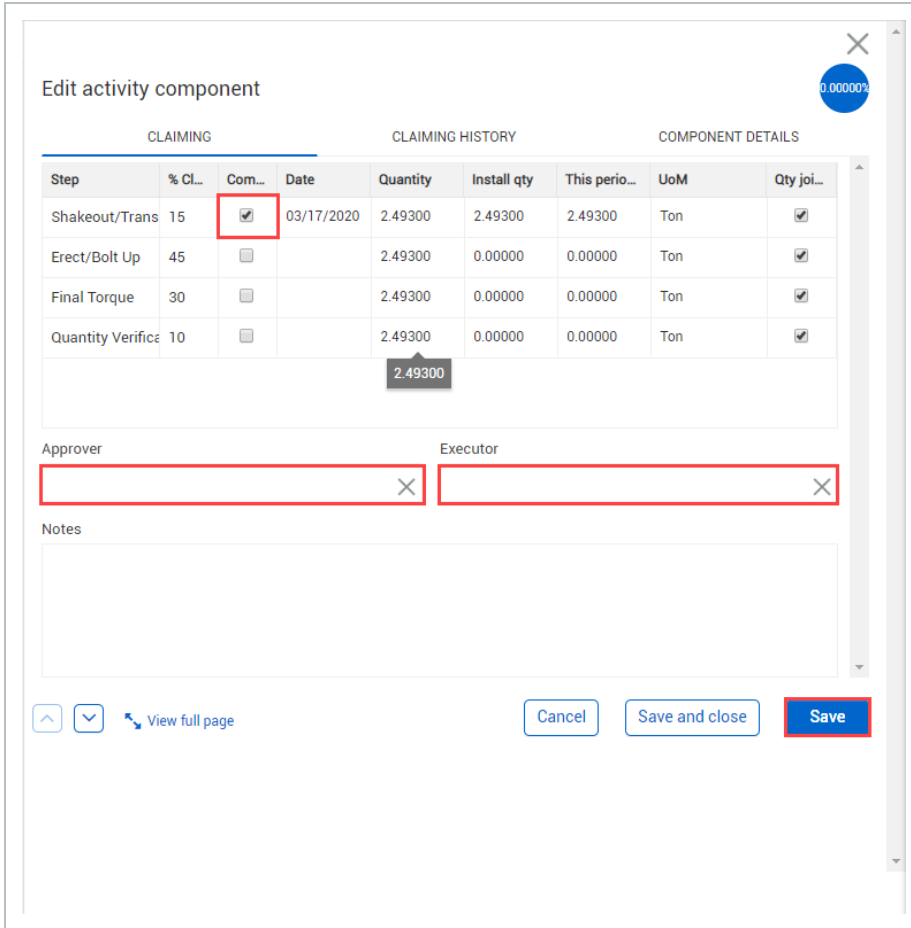

6. At the bottom of the slide out panel, click **Save**.

Select **Save** to have claimed quantities be added/deducted from your percent complete or to show up in your claiming history report.

- Notice that the percentage indicator in your component view has changed

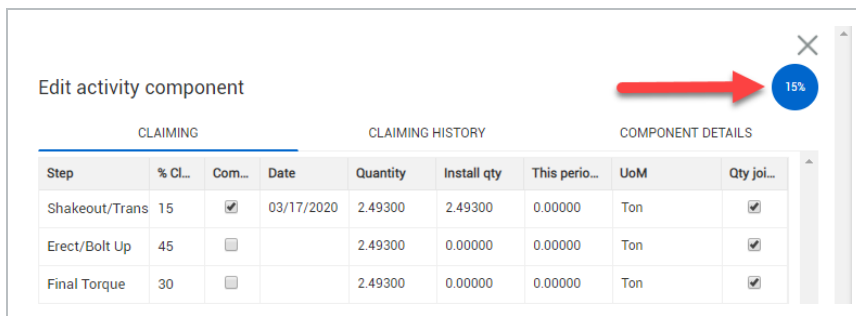

You can also claim a portion of the quantity for a single step by inputting the quantity in the **This Period** cell.

The screenshot shows the 'Edit activity component' interface with a 15% progress indicator. It features three tabs: CLAIMING, CLAIMING HISTORY, and COMPONENT DETAILS. The CLAIMING tab is active, displaying a table with the following data:

Step	% Cla...	Com...	Date	Quantity	Install qty	This period...	UoM
Shakeout/Transp	15	<input checked="" type="checkbox"/>	10/31/2018	2.49300	2.49300	0.00000	Ton
Erect/Bolt Up	45	<input type="checkbox"/>	10/31/2018	2.49300	1.00000	1.00000	Ton
Final Torque	30	<input type="checkbox"/>		2.49300	0.00000	0.00000	Ton
QC Verification	10	<input type="checkbox"/>		2.49300	0.00000	0.00000	Ton

To claim in the Plan Quantity Tracking module, the component WBS must have **Allow-As-Built** set to **All** or **Quantities** in InEight Control. See your Control Manager to verify this setting if unable to claim the component. The same scenario follows for claiming in data blocks.

5.2.4 Over claim component quantity

With the applicable permissions, you can overclaim component quantity using the Allow overclaiming of components toggle.

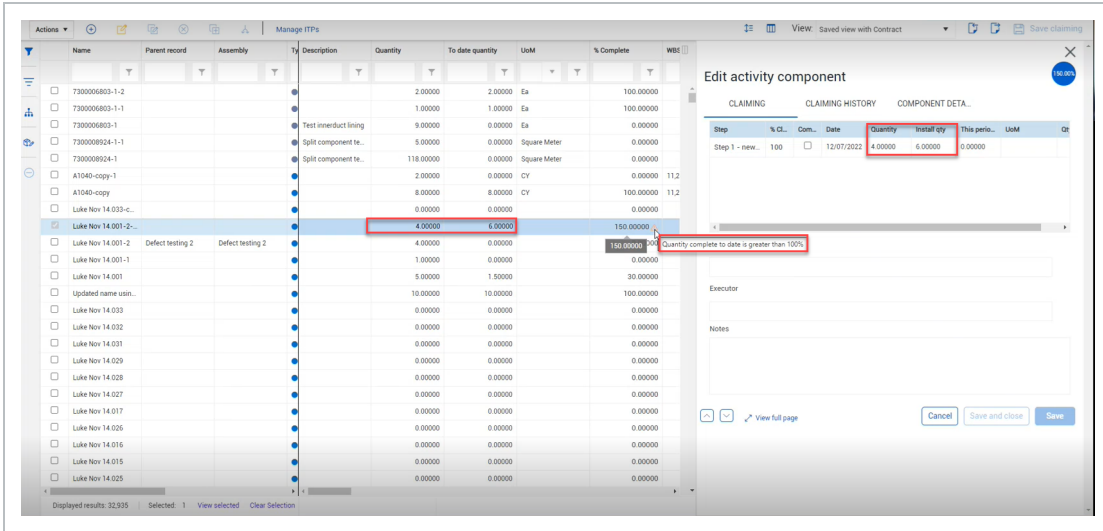

When the component is claimed over 100%, the toggle is locked in the Global options.

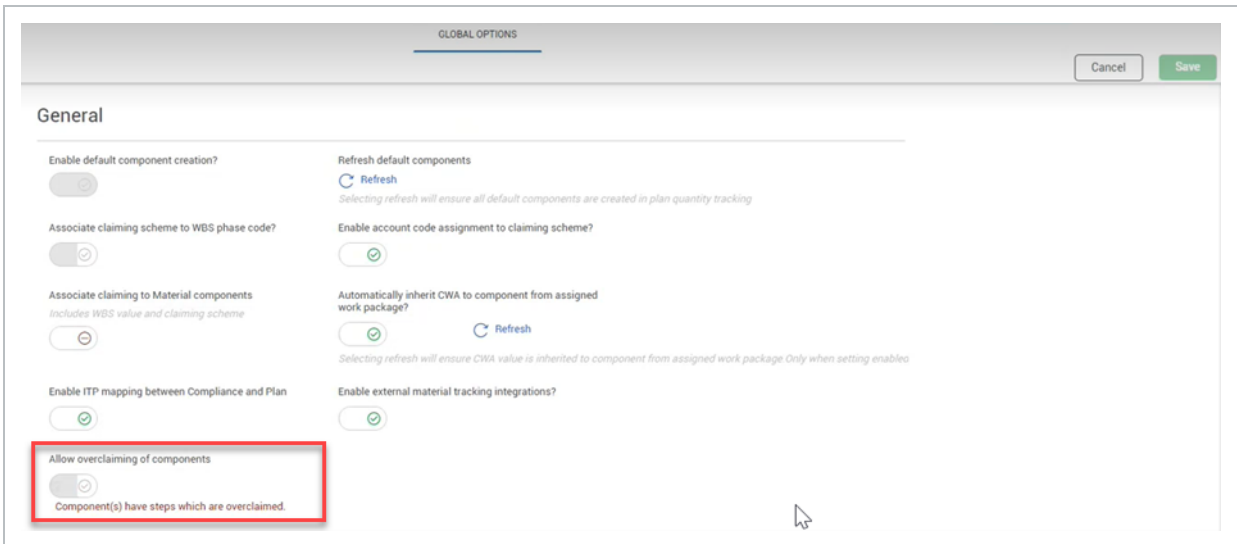

When the component is complete, the % complete is set to 100.

Step name [1]	Step % [1]	Com...	Quantity [1]	Installed qty [1]	This period qt...	UoM [1]	Date [1]	Executor [1]
Step 1	100	<input checked="" type="checkbox"/>	2.00000	2.00000	0.00000	Ea	12/05/2022	
Step 1	100	<input checked="" type="checkbox"/>	1.00000	1.00000	0.00000	Ea	12/05/2022	
Step 1	100	<input type="checkbox"/>	9.00000		0.00000	Ea		
Step 1 - new t...	100	<input type="checkbox"/>	0.00000	0.00000	0.00000			
Step 1 - new t...	100	<input checked="" type="checkbox"/>	4.00000	4	-2.00000		12/07/2022	

5.2.5 Claiming in the Data Blocks View

In the following Step by Step you will claim quantities in the Data Blocks view.

Quantity Claiming (Data Blocks View)

1. Navigate to the **Quantity Tracking** page and select **View As button** to see your workspace in Data Blocks view.
2. Turn on the **[your name] filter** that you created in *Quantity Tracking Lesson 2 – General Navigation* using the filter drop-down menu on the right toolbar.
3. Select the check box in the Complete column of the Step 1 data block for three of the components in your module.

If the Step 1 data block is not shown, click **Manage step columns**, and then select the step in the dialog box.
4. Click the **Save** button in the upper right of the page.

You can also claim using percentage complete or to-date installed quantity at the component step level.

In data block view, there is an Apply installed quantity to all button at the top of each Step data block. You can use this button to apply an installed quantity to all components in your current view.

You can only apply installed quantity up to 50 components at a time, so you must filter your view first to show only the components you want to apply the installed quantity to.

The following Step by Step shows you how to apply an installed quantity to multiple components.

5.2 Step by Step 1 – Apply Installed Quantity to All

1. Filter your view to show only the components you want to apply an installed quantity to.
2. Click **Apply installed quantity to all**.
3. Enter the install date.

The screenshot shows a dialog box titled "Apply installed quantity to all". On the left, there is a table with the header "Installed qty" and five rows, each containing the value "0.00000". The dialog has two main sections. The first section is "Install date" with a date picker set to "11/22/2021". The second section contains two radio button options: "Step JTD installed qty" (which is selected) and "Step JTD % complete". Each option has an associated "input" field. At the bottom of the dialog are "Cancel" and "Apply" buttons.

4. Select either the quantity or percentage options.
5. Enter a quantity or percentage in the field.

If you apply a certain amount that exceeds a component's remaining quantity, all the remaining quantity is installed.

6. Click **Apply**.

The changes are flagged as pending in each row.

7. Click **Save claiming**.

You have now claimed multiple items as complete by using the Data Block view. You can use the Standard Grid view and bring in columns for each claiming step to claim in that view also. Some setup is required for this option.

5.3 EDIT CLAIMED QUANTITIES

This topic covers how to edit the claimed quantity of a component in the InEight Plan application.

It is possible that you may need to update the quantity that has been claimed for a component. You might find the need to:

- Claim more quantity for a step in a specific component
- Back out quantity that was reported incorrectly

5.3.1 Quantity Joined

In Quantity Tracking, when the quantity joined box is unchecked for a step in the claiming scheme, the step quantity and the component quantity are no longer connected. Any updates made to the component quantity will not be reflected for that step. You can re-join step quantities with the component quantity.

ClaimingSchemes ^										
Step	% Cla...	Com...	Date	Quantity	Install qty	This period...	UoM	Executor	Approver	Qty joined
Assemble	25	<input type="checkbox"/>		5.00000	0.00000	0.00000	LF			<input type="checkbox"/>
Erect	25	<input type="checkbox"/>		10.00000	0.00000	0.00000	LF			<input type="checkbox"/>
Detail	40	<input type="checkbox"/>		5.00000	0.00000	0.00000	LF			<input type="checkbox"/>
Verification & Do	10	<input type="checkbox"/>		1.00000	0.00000	0.00000	LF			<input type="checkbox"/>

You can re-join step quantities with the component quantity. By checking the re-join box, the step quantity is linked again to the component quantity, so when the component quantity is changed, the step quantity will automatically change along with it.

ClaimingSchemes ^										
Step	% Cla...	Com...	Date	Quantity	Install qty	This period...	UoM	Executor	Approver	Qty joined
Assemble	25	<input type="checkbox"/>		10.00000	0.00000	0.00000	LF			<input checked="" type="checkbox"/>
Erect	25	<input type="checkbox"/>		10.00000	0.00000	0.00000	LF			<input type="checkbox"/>
Detail	40	<input type="checkbox"/>		10.00000	0.00000	0.00000	LF			<input checked="" type="checkbox"/>
Verification & Do	10	<input type="checkbox"/>		10.00000	0.00000	0.00000	LF			<input checked="" type="checkbox"/>

5.3.2 Quantity Editing

In InEight Plan you can edit quantities by adding or subtracting quantities from components. The following step-by-step shows how to edit claimed quantity.

Edit Claimed Quantity

1. In the **Quantity Tracking** page, select a component.

Quantity claiming changes are best made in the Data Blocks view.

2. Find and select the check box to the left of one of the components you created.
3. Click the **Edit** icon to open the Edit component slide out panel.

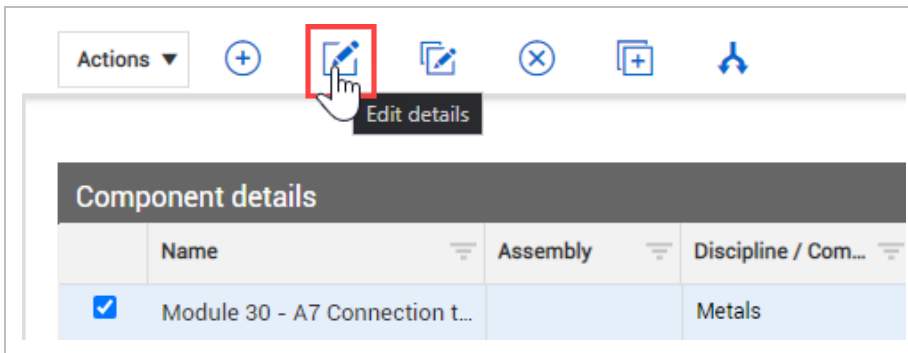

4. On the Edit activity component slide out panel, click on the **Claiming History** tab.
5. Click on the **Edit** icon for your latest entry.

15%

Edit activity component

CLAIMING CLAIMING HISTORY COMPONENT DETAILS

Install date: 03/17/2020
Increment: 0.37395
Changed date: 03/17/2020
Changed by: Vicky Pierce
Daily plan ID:

Approver: Vicky Pierce

Executor:

Notes:

Cancel Save and close Save

View full page

- You can only change the Approver and Executor, and add notes
 - You cannot change the quantity and date information on the left
 - This preserves an audit trail to document accurately the claiming of this component
6. Click on the **Claiming** tab.
 7. Deselect the **Complete** checkbox for one of your steps.
 8. Enter a number in the Installed quantity field of that step.

- Note that the This Period quantity automatically recalculates

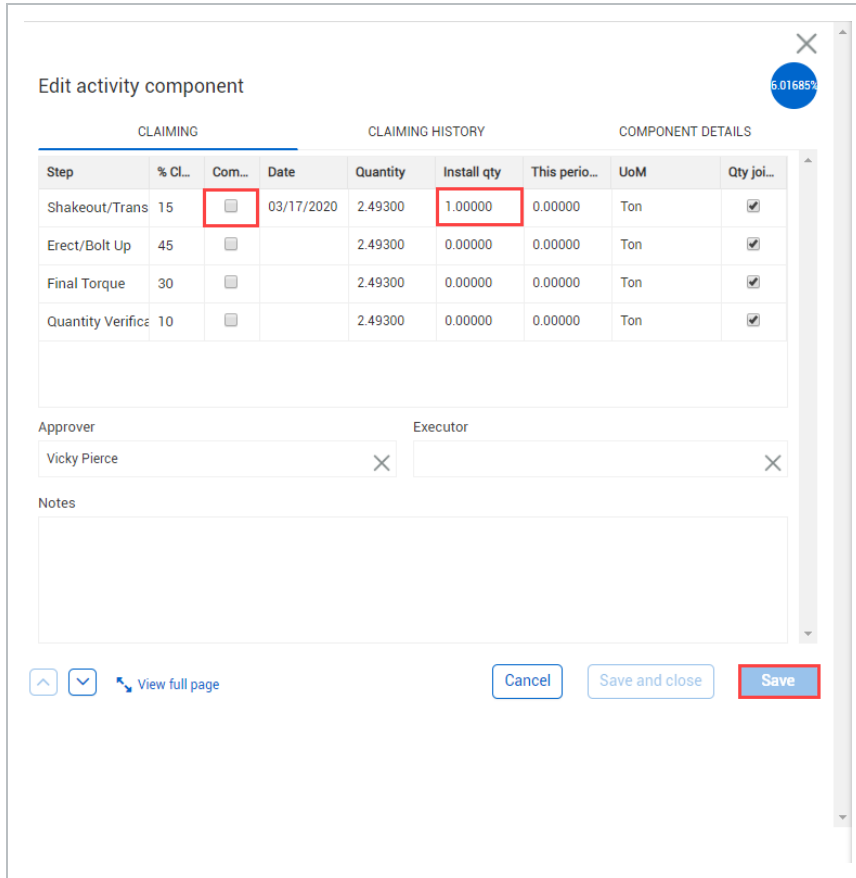

9. When integrated with InEight Design, the Delayed check box lets you mark steps as delayed for further processing on component records.

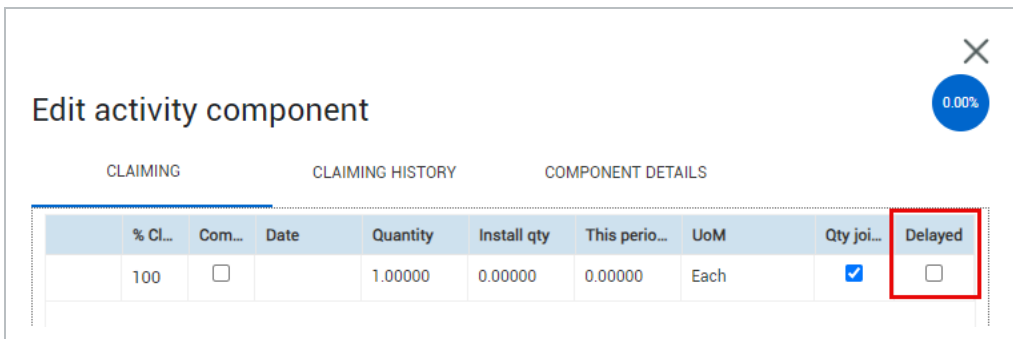

10. Click **Save**.
11. Click the **Claiming History** tab.

- You can now see your new entry with its negative quantity adjustment along with the original entry.

Batch Edit Claimed Quantity

The following step-by-step shows how to batch edit claimed quantities.

Batch Quantity claiming changes must be made in the Data Blocks view.

- In the **Quantity Tracking** page, change quantities to one or more components in the Quantity column
- You can free text and change quantities for multiple components under the quantity column. A blue dot will show unsaved changes.

Actions	Name	Parent record	Assembly	Type	Discipline / Commodity	Claiming scheme	WBS	Quantity	To date quantity	UoV
<input checked="" type="checkbox"/>	demo today-copy2			Activity	Electrical	810004 - Install b...	1317	20.00000	0.00000	Ea
<input type="checkbox"/>	demo today-copy			Activity	Electrical	810004 - Install b...	1315	12.00000	0.00000	Ea
<input type="checkbox"/>	demo today-1			Activity	Electrical	810004 - Install b...	1315	2.00000	0.00000	Ea
<input type="checkbox"/>	demo today			Activity	Electrical	810004 - Install b...	1315	8.00000	0.00000	Ea
<input type="checkbox"/>	Everybody		Everybody	Assembly	Anchor Bolts			2.00000		
<input type="checkbox"/>	Everybody		Everybody	Assembly	Anchor Bolts			2.00000		

Displayed results: 30,992 | Selected: 1 | [View selected](#) | [Clear Selection](#)

- Click **Save changes**.